

The information and specifications included in this publication were in effect at the time of approval for printing. Honda Motor Co., Ltd., reserves the right, however, to discontinue or change specifications or design at any time without notice and without incurring any obligation.

Accessories Precautions

The GPS antenna is located in the dashboard. Metallic front or side window tinting can seriously degrade or obstruct GPS reception.

Signal noise from devices such as radar detectors, vehicle tracking devices, remote starters, and additional amplifiers can disrupt the navigation system. If you install any such item, install it away from the navigation display and antenna.

Important Safety Information



Using the navigation system while driving can take your attention away from the road, causing a crash in which you could be seriously injured or killed.

Only operate system controls when the conditions permit you to safely do so.

Avoid focusing on the screen or manually operating the system controls while driving.

Enter information before you begin driving or when stopped. As you drive, listen to the audible instructions and use voice commands when possible. Pull to the side of the road if you need more time to look at the screen or operate the controls.

Route guidance may conflict with street closures, road construction, detours, and out-of-date map data.

The system itself may also have limitations. Verify route information by carefully observing roads, signs, and signals. Always use your own judgment and obey traffic laws.

➤ **System Limitations** P. 294

Contents

➤ System Setup P. 19

Start-up 20	Voice Control System 22	Interface Settings 25	Personal Information 36
Routing 49	Guidance 57	Map 65	Data Reset 81
Touchscreen 82			

➤ Navigation P. 83

Entering a Destination 84	Calculating the Route 108	Driving to Your Destination 110	Map Menu 116
Changing Your Route 122	Changing Your Destination 131	Resuming Your Trip 134	

➤ Audio P. 135

Audio System 136	Audio Remote Controls 142	Audio Settings 143	Playing FM/AM Radio 147
Playing XM® Radio 153	Playing a Disc 158	Playing Hard Disc Drive (HDD) Audio 165	
Playing an iPod® 177	Playing Internet Radio 189	Playing a USB Flash Drive 193	Playing <i>Bluetooth</i> ® Audio 199

➤ *Bluetooth*® HandsFreeLink® P. 203

<i>Bluetooth</i> ® HandsFreeLink® 204	Text Message/E-mail 233
---------------------------------------	-------------------------

➤ Rear Entertainment System P. 245

Rear Entertainment System 246	Rear Control Panel Operation 250	Front Control Panel Operation 261	Wireless Headphones 265
-------------------------------	----------------------------------	-----------------------------------	-------------------------

➤ Other Features P. 269

Trip Computer 270	Calendar 271	Information Functions 272	Multi-view Rear Camera 274
-------------------	--------------	---------------------------	----------------------------

➤ Troubleshooting P. 277

Troubleshooting 278	Error Messages 284
---------------------	--------------------

➤ Reference Information P. 291

System Initialization 292	System Limitations 294	Customer Assistance 296	Legal Information 299
---------------------------	------------------------	-------------------------	-----------------------

➤ Voice Commands P. 307

Voice Commands 308

Quick Reference Guide P.2

System Setup P.19

Navigation P.83

Audio P.135

***Bluetooth*® HandsFreeLink®** P.203

Rear Entertainment System P.245

Other Features P.269

Troubleshooting P.277

Reference Information P.291

Voice Commands P.307

Index P.323

Overview—Functions at a Glance

Navigation

You can select any place/landmark as a destination by using voice control or the Interface Dial. The navigation system gives you turn-by-turn driving directions to your destination.



Store home address

Register **1** home address.

Store contacts

Store up to **200** contacts in an address book.

Enter destination

Select your destination using **12** methods.

Select route

Set route preferences and select one of **3** routes.

Track route

Follow your route in real-time with voice guidance.

Avoid certain areas

Set streets and areas to detour around.

Add waypoints

Add up to **4** “pit stops” along your route.



Audio

The advanced audio system provides clear, well-defined sound and makes the most of your music. Enjoy listening to a variety of audio sources, such as:



FM/AM Radio ➔ P.147

XM® Radio ➔ P.153

Compact Disc ➔ P.158

Hard Disk Drive (HDD) ➔ P.165

iPod® ➔ P.177

Internet Radio ➔ P.189

USB Flash Drive ➔ P.193

Bluetooth® Audio ➔ P.199



Rear Entertainment System ➔ P.246

Rear seat passengers can enjoy a completely separate entertainment source than front passengers, including movies, games, and other audio choices.



Voice Control ➔ P.22

Use voice commands for safer system control while driving. You can operate all key functions of the navigation, audio, *Bluetooth®* HandsFreeLink®, and climate control systems.

Bluetooth® HandsFreeLink® ➔ P.204

Pair a compatible cell phone to receive incoming and make outgoing calls. You can operate the phone features without ever taking your hands off the wheel.

Other Features

Multi-view Rear Camera ➔ P.245

Helps you check for obstacles around the rear of your vehicle on the navigation screen when reversing.

System Controls

- 1 PHONE Button → P.206
- 2 NAV Button → P.84
- 3 BACK Button
- 4 (Display Mode) Button → P.70
- 5 Interface Dial/ENTER Button → P.7
- 6 INFO Button
- 7 MENU Button
- 8 SETTINGS Button

Models with RES

- 9 FRONT AUDIO Button
- 10 REAR AUDIO Button → P.261
- 11 REAR (Power) Button

- Navigation
- Rear Entertainment System
- Bluetooth® HandsFreeLink® Voice Control
- Audio

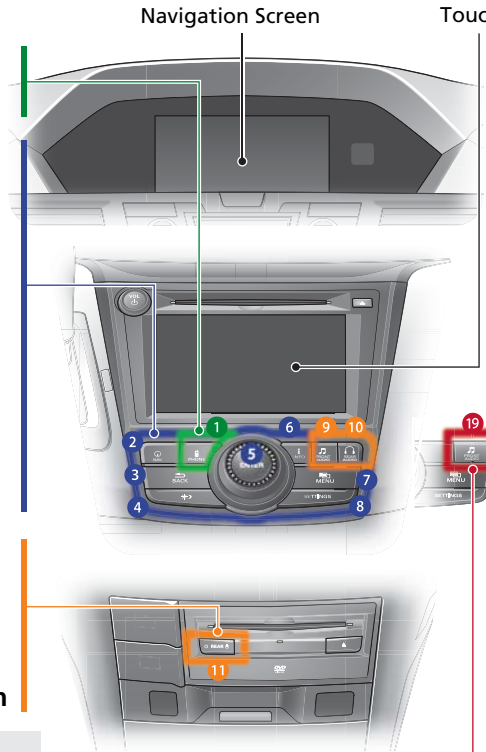

Touchscreen

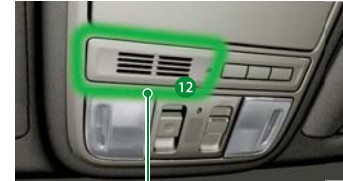

12 Microphone → P.22



- 13 MODE Button → P.142
- 14 VOL Button → P.142
- 15 CH Button → P.142





- 16 (Pick-Up) Button → P.204
- 17 (Hang-Up/Back) Button → P.204
- 18 (Talk) Button → P.204

Models without RES

- 19 AUDIO Button

Voice Control Operation







Voice Portal Screen

- 1 Press and release the  (Talk) button on the top screen of any mode. The system prompts you to say a voice command and gives examples. Press and release the  (Talk) button again to bypass this prompt.





- The system beeps when ready for a command. Press the  (Hang-Up/Back) button to cancel.
- Available voice commands are highlighted on the screen.

- 2 Say a voice command (e.g., Address). After that, follow the voice prompt and say a voice command.



- The audio system is muted during voice control mode.
- You can use other voice commands on the Voice Portal screen. **Voice Command Index**  **P.308**
- Say  "Voice Help" to enter supported commands for the current screen. A voice help tutorial is also available. **Voice Help**  **P.15**
- During the voice control mode, press and hold the  (Hang-Up/Back) button to return to the Voice Portal screen.
- Set **Voice Prompt to Off** to bypass the voice prompt. **Voice Recognition Settings**  **P.24**
- Carefully read the usage note for the voice control. **Voice Control System**  **P.22**

On the Menu Screen

- 1 Press and release the  (Talk) button on the menu or setting screen. The system prompts you to say a voice command and gives examples. Press and release the  (Talk) button again to bypass this prompt.



Available voice commands are highlighted on the screen.

- 2 Say a voice command.
 - Say  "Voice portal" to display the Voice Portal on any screen.
 - Say  "Voice Help" to enter supported commands for the current screen. A voice help tutorial is also available. **Voice Help**  **P.15**

Touchscreen Basic Operation

Shortcuts



Audio Source

Select to change an audio source.



Presets

Select to store a station.







More

Select to display the menu items.



● **AM, FM, XM, Pandora® , Aha™**



-   : Select the preset station (AM/FM/Pandora®/Aha™) or category (XM).
-   : Select to search the selected band for a station with a strong signal. (AM/FM)
Select the channel. In channel mode, select and hold to change the channel rapidly. (XM)
Select a song (Pandora®) or a contents (Aha™).

● **CD, HDD, USB flash drive, Bluetooth® Audio**

-   : Select  to skip to the next folder, and  to skip to the beginning of the previous folder.
-   : Select to change tracks. Select and hold to move rapidly within a track.

● **iPod®**

Album bar : Select an album.

-   : Select to change tracks. Select and hold to move rapidly within a track.

Interface Dial/ENTER Button Operation

Rotate dial

Changes scale
Map screens



Highlights menu options
Menu screens



You will see these icons in each chapter.
They represent how you can operate the Interface Dial.

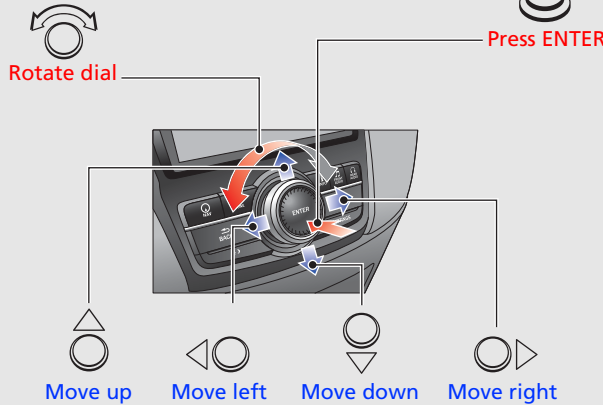

Move
 up  down  left  right

Scrolls map
(8 directions)

Map screens



Selects labeled
function

Menu screens



Press ENTER

Selects function
Selects map icon

Map screens



Selecting Icon

Selects highlighted option

Menu screens





How to Enter Information

You can enter information (e.g., city names, street names, personal names, and business names comprising letters, numbers, and symbols) when prompted on input screens by two different methods.





Using Voice Control

When you see  in this manual, voice commands are available for that feature.

- Say the letter, number, or symbol (e.g., say  "A").
- Use spelling assist (e.g., say  "Alpha" to enter the letter "A" or  "Hyphen" to enter a hyphen).
- The system beeps if you say an unavailable (grayed out) letter or number.
- If a voice command is not recognized, a list is displayed with possible options.





On list screens:



- Say the number of the list item (e.g., say  "Five" to select item 5).
- Say  "Up" or  "Previous" to scroll up one page.
- Say  "Down" or  "Next" to scroll down one page.

Using the Interface Dial

Rotate  to highlight a character.

- Select  to display upper/lower case characters.
- Select **Sym** to display symbols and accented characters.
- Select **Edit** (or move ) to edit the entered characters.

Press  to enter the highlighted character.

- Move  to select **Space** to enter a space character.
- Move  to select **Delete** to remove the last entered character.

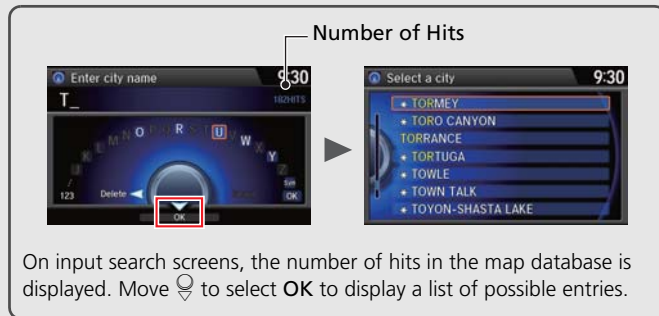

On input search screens, the number of hits in the map database is displayed. Move  to select OK to display a list of possible entries.

- You can also use the touch screen to enter information.

Scrolling through lists or tabs is limited while the vehicle is moving. **Certain screen functions are limited or inoperable while the vehicle is moving. For these functions, use available voice commands or pull over to proceed.**



Map Screen Legend

Current map scale

Map orientation 









 North up  3D map
 Heading up

GPS signal strength



 Best reception
 Good reception
 No icon: Poor/No reception

Map scale 

Feature areas

 Park	 Airport/Business
 Hospital	 Water Area
 Shopping Mall	 Cemetery
 Golf Course	 University



Traffic status indicator 

 Traffic information available
 Traffic information off or map scale too large
 No icon: Out of coverage area

Traffic incident icons 

-  Congestion
-  Incident
-  Weather
-  Construction
-  Road Closed

Traffic flow indicator 



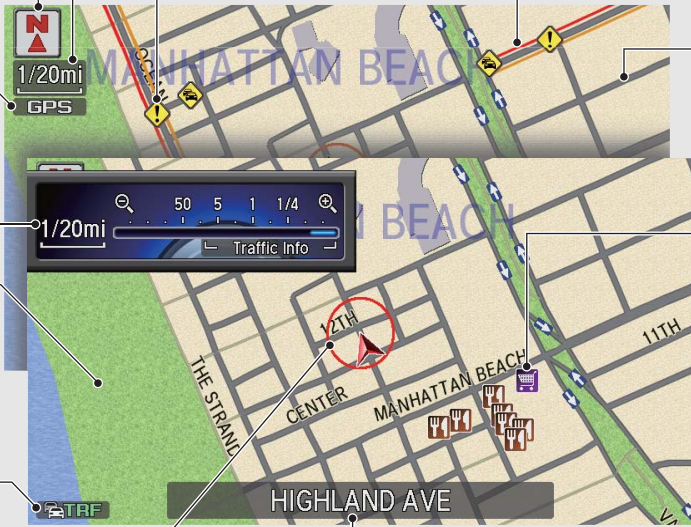









 Heavy (approx.)
 surface: 0 to 20 mph
 freeway: 0 to 25 mph
 Moderate (approx.)
 surface: 21 to 30 mph
 freeway: 25 to 52 mph



Streets

-  Freeways
-  State routes
-  Verified streets
-  Unverified streets
-  One-way streets

Landmark icons 

-  Acura dealer
-  Honda dealer
-  ATM
-  School
-  Parking lot
-  Parking garage
-  Grocery store
-  Hotel/Lodging
-  Gas station
-  Hospital
-  Post office
-  Restaurant
-  Freeway exit information

Current vehicle position



Current street name

During Route Guidance

During route guidance, route information is displayed on the map screen and guidance screen. Press the NAV button to toggle between the map and guidance screen.

Map Screen

Tracking dots

Guide to destination or waypoint

Estimated time to destination (waypoint)

Distance to destination (waypoint)

Distance of the actual route.

Waypoint

Calculated route

Next guidance indicator

Distance to the next guidance point.

Calculated route (unverified roads)

Destination icon

Map Menu

Contains map or routing options.



Guidance Screen

Guidance point

Guide to destination or waypoint

Estimated time to destination (waypoint)

Distance to destination (waypoint)

Distance of the actual route.

Guidance indicator

Street name of guidance point and distance to the guidance point.

Lane guidance

Guidance point

No entry icon

Day or Night Mode

Press the (Display mode) button to manually switch between day and night mode.

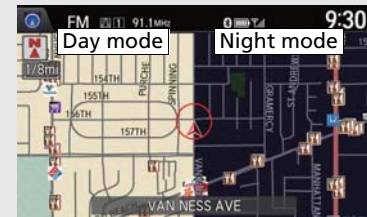

Navigation—Home Addresses and Going Home

The “Home” feature automatically routes you to your home address from any location simply by selecting Go Home, or saying “Go Home.”

Storing Your Home Address

- 1 Press the **SETTINGS** button.



- 2 Rotate to select **Navi Settings**. Press .



- 3 Rotate to select **Edit Go Home**. Press .

- 4 Rotate to select **Name**. Press .



- 5 Enter a name.



- 6 Rotate to select **Address**. Press .

- 7 Enter an address.

- 8 Rotate to select **Phone No.** Press .

- 9 Enter a phone number.



- 10 Move and rotate to select **OK**. Press .

Going Home

- 1 From the map screen, press the **MENU** button.



- 2 Rotate to select **Go Home**. Press .



Alternatively, you can say “Go Home” from any screen. Your home address is displayed on the Calculate Route screen.



- 3 Rotate to select **Set as Destination**. Press .

Navigation—Entering a Destination



Enter your destination using one of several methods, then follow route guidance on the map or guidance screen to your destination. You can also perform these steps using  voice commands.

- 1** From the map screen, press the MENU button.



- 2** Rotate  to select **Address**. Press .





- 3** Rotate  to select **Street**. Press .



- 4** Enter the name of your destination street.





- 5** Rotate  to select your destination street from the list. Press .



- 6** Enter the street number. Move  to select **OK** when finished.



- 7** If there is more than one city with the specified street, a list of cities is displayed. Rotate  to select the desired city from the list. Press .



- 8** Rotate  to select **Set as Destination**. Press .

Route guidance to the destination begins.

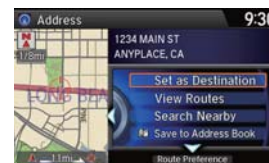

- **View Routes:** Choose one of three routes.



- **Route Preference:** Choose Max or Min for the five settings.











Navigation—Changing Route or Destination

You can alter your route by adding waypoints to visit, adding streets to avoid, or changing your destination during route guidance.

Adding a Waypoint (“Pit Stop”)



You can add up to four waypoints along your route. ➔P124

- 1 From the map screen, press the MENU button.
- 2 Rotate  to select **Destination List**. Press .
- 3 Rotate  to select **Add New Destination**. Press .
- 4 Rotate  to select **Find Along Route**. Press .

- 5 Rotate  to select location and search method. Press .







- **Search Around:** Search around a location.
- **Search Along:** Search between two locations.



- 6 Select the icon category and location to add to the Destination List when prompted. Edit the order of destinations if necessary.
- 7 Move  and rotate  to select **Start Route**. Press .

Changing Your Destination

There are four methods you can use to specify a new destination during route guidance.



- Say  **“Find Nearest...”** ➔P131
Searches for the nearest place/landmark on the map screen (e.g.,  **“Find nearest gas station”**).
- Say  **“Go Home”** ➔P11
Routes to your home address.
- Selecting an icon on the map ➔P132
Scroll the map to position the cursor over a place/landmark icon or a new area on the map. Press  twice.
- Entering a new destination ➔P133
Press the MENU button. Move  to select **Destination** and enter a new destination.

Canceling Your Route

- 1 Press the MENU button.
- 2 Rotate  to select **Cancel Route**. Press .



From the map screen:

- 1 Press  on the map screen.
- 2 Rotate  to select **Cancel Route**. Press .



Rear Entertainment System

The rear passengers can enjoy a wide array of audio/visual sources with the Rear Entertainment System (RES). The rear passengers can use wireless headphones and operate the system with the rear control panel.

Overhead Screen and Rear Control Panel

RES

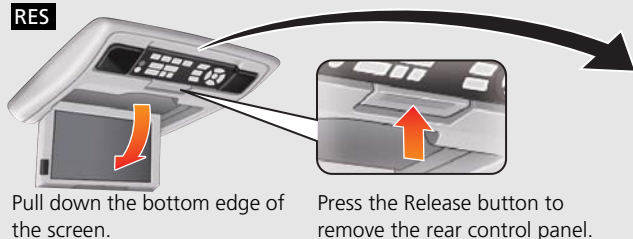

Ultrawide RES



Basic Operation

1 Open the overhead screen.

2 Press the REAR  (Power) button on the front control panel.





3 Select the audio source.

• **RES:** Press the desired button on the rear control panel.



• **Ultrawide RES:** Press the SOURCE button and rotate the Interface Dial to select an audio source. Press the ENTER button.

 **(Power) Button**
Turn the system on or off (when rear power is turned on).

 **(Light-up) Button**
Illuminate the buttons on the rear control panel.

CH/FOLDER Bar
Select a channel (Radio) or a folder (Disc/USB).

TUNE/SKIP Bar
Find stations (FM/AM). Skip to start/end of tracks, or press and hold to fast reverse/fast forward (Disc/USB/DVD).

CATEGORY Bar
Select a category (XM).

 **(Play/Pause) Button**
Play or pause the playback.

TITLE SCROLL Bar
Display track title, artist, and other text information.

Voice Help

This navigation system comes with voice help, which shows you what command to say when using the voice command functions.

Command Help

- 1 Press and release the  (Talk) button.

- 2 Say  "Voice Help."





The voice help screen is displayed. The  "Voice Help" command is available on most screens.

- 3 Press and release the  (Talk) button.

- 4 Say one of the options for a list of available commands by category (e.g.,  "Navi commands").



- 5 Press and release the  (Talk) button.



- 6 Say one of the options for a list of available commands by category (e.g.,  "Route commands").



- 7 The system displays a list of all available commands for the category. Press  to hear the list read aloud.



Getting Started Tutorial



- 1 Move  and rotate  to select **Getting Started** on the voice help screen. Press .



For "Voice Settings" and "All Commands."  **P307**

- 2 Press  to have the system read the tips for the voice control.



- Rotate  to read the tips.
- Move  or  to display the previous/next page.

Troubleshooting

For more Information  P.277



Why does the vehicle position icon on the map “lag” a short distance behind my actual position, especially at intersections?



This is normal. The navigation system is unaware of the width of intersections. Large differences in vehicle position can indicate a temporary loss of the GPS signal.



Why does the “time to destination” display sometimes increase even though I am getting closer to my destination?



The “time to destination” is based on your actual road speed and traffic conditions to give you a better estimate of arrival time.



How do I specify a destination when an entered city or street could not be found?







Try entering the street first. Some cities are lumped in with a major metro area. In rural “unverified” areas or new subdivisions, streets may be missing or only partially numbered.



How do I turn on the navigation system voice guidance?





1. Press the **SETTINGS** button. Rotate  to select **System Settings** and press . Check that **Volume** is not set to **0**.
2. Move  or  to select **Voice Rec.** Set **Voice Prompt** to **On** if you want the system to provide confirmations and system prompts.



My battery was disconnected or went dead, and the navigation system is asking for a code. Where do I find it?



In most cases, you do not need to enter a code. Simply press and hold the  (Power) button for two seconds; the system should reactivate.
 **System Initialization** P. 292

How to Use This Manual

This section explains different methods on how you can easily find information in this manual.



Searching the Table of Contents



Two types of Tables of Contents help you find your desired information.

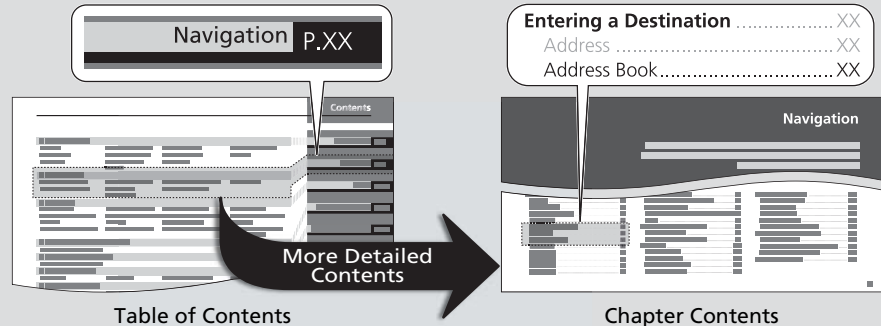

First, find the general chapter related to what you are looking for (e.g., entering a destination from the Address Book). Then, go to that chapter to view a more specific table of contents.

This more detailed table of contents shows you exactly what information is listed by section and title.



Searching the Index



Menu items displayed on the navigation screen (e.g., Address Book) can be found individually in the Index.

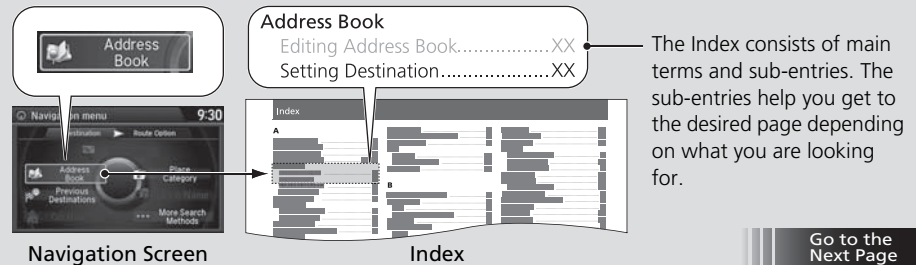

Go to the Next Page

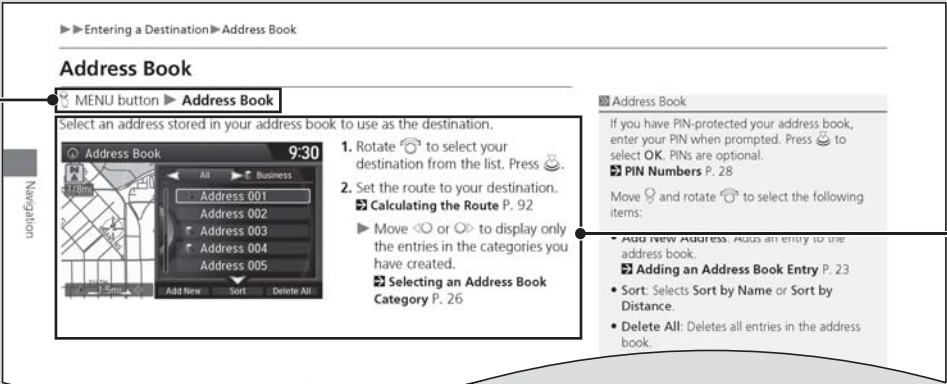

After following the menu tree, step-by-step instructions explain how to achieve the desired result.

Menu Tree

The menu tree helps guide you through the system's menu options. To get to your desired function, follow the menu tree in order of the steps shown.

NOTE:
All menu options can also be activated with voice commands.

MENU button ▶ Address Book

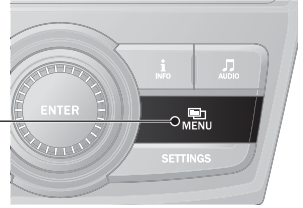

Press the hard button on the system control panel.

Press the MENU button.



Select the menu option with the Interface Dial.

Rotate to select Address Book. Press .

Sample pages and images in this section may differ from the actual ones.

System Setup

This section describes the start-up procedure and the navigation and setup functions.



Start-up	20	Guidance	57	Touchscreen	82
Voice Control System	22	Guidance Mode	58	Changing the Screen Settings	82
Command Input	22	Street Name Guidance	60		
Voice Recognition	23	Non-map screens	61		
Interface Settings	25	Guidance Point	63		
Personal Information	36	Estimated Time	64		
Address Book	37	Map	65		
Home Address	42	Showing Icons on Map	67		
PIN Numbers	43	Color	69		
Previous Destination	44	View (Map Orientation)	72		
Category History	45	3D Angle Adjustment	73		
Download POI	46	Straight Line Guide	73		
Routing	49	Current Location	74		
Route Preference	50	Map Legend	75		
Unverified Routing	51	Display Tracking	79		
Traffic Rerouting	53	Correct Vehicle Position	80		
Edit POI Search Radius Along Route	54	Data Reset	81		
Avoided Area	55	Defaulting All the Settings	81		

The navigation system starts automatically when you set the power mode to ACCESSORY or ON. At start-up, the following Confirmation screen is displayed.

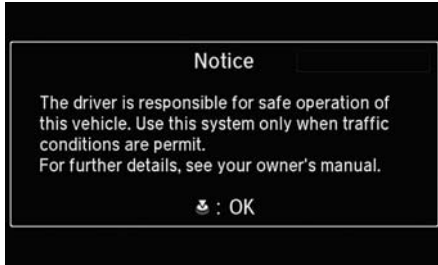

1. Press  to select **OK**.
 - ▶ If you do not select **OK**, the map screen is displayed after a certain period of time.
 - ▶ Your current position is displayed on the map screen.
2. Press the NAV button if a different mode is selected.
 - ▶ Your current position is displayed on the map screen.

Start-up

If the navigation system loses power at any time, you may need to press and hold the  (Power) button for more than two seconds, or you may be prompted for the five-digit security code.

➤ **System Initialization** P. 292

“OK” on the Confirmation screen cannot be selected by using a voice command.

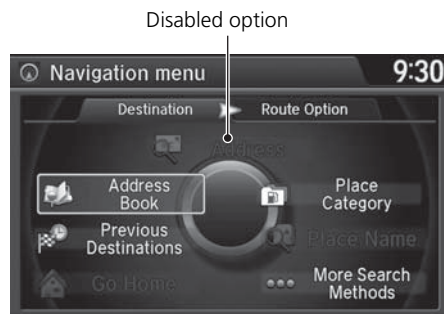

■ Limitations for Manual Operation



Certain manual functions are disabled or inoperable while the vehicle is in motion. You cannot select a grayed-out option using the Interface Dial until the vehicle is stopped.

Voice commands are still operable while the vehicle is in motion.

Your vehicle has a voice control system that allows hands-free operation of most of the navigation system functions.

The voice control system uses the  (Talk) and  (Hang-Up/Back) buttons on the steering wheel and a microphone near the map lights on the ceiling.

A “Getting Started” feature provides a tutorial that explains how to use the voice control system.

➤ **Getting Started Tutorial** P. 15

Command Input

If the system does not understand a command or you wait too long to give a command, the system asks you to repeat the command.

When you give a command, the system generally either repeats the command as a confirmation or asks you for further information. If you do not wish to hear this feedback, you can turn it off. However, listening to the feedback will help familiarize you with the way the system expects commands to be phrased.



If the system cannot perform a command or the command is not appropriate for the screen you are on, the system beeps.

On character input screens, a list of possible characters is displayed if the system does not recognize your command.

You can find out which voice commands are available for a particular screen using the  “Voice Help” command. The system will display and read the list of available commands to you.

➤ **Voice Help** P. 15

➤ (Talk) Button

When you press the  (Talk) button, the system prompts you to say a voice command and gives examples. Press and release the  (Talk) button again to bypass this prompt and give a command.

➤ Command Input

The audio system is muted while using the voice control system.

Voice Recognition

To achieve optimum voice recognition when using the navigation voice control system:

- Make sure the correct screen is displayed for the voice command that you are using.
 ▶ **Voice Commands** P. 308
- Close the windows and moonroof.
- Adjust the dashboard and side vents so air does not blow onto the microphone on the ceiling.
- Speak clearly in a clear, natural speaking voice without pausing between words.
- Reduce any background noise if possible. The system may misinterpret your command if more than one person is speaking at the same time.
- Refer to the Voice Help feature.
 ▶ **Voice Help** P. 15

▶ Voice Recognition

The voice control system can only be used from the driver's seat because the microphone unit removes noises from the front passenger's side.

Voice Recognition Settings

🔑 SETTINGS button ▶ System Settings ▶ Voice Rec

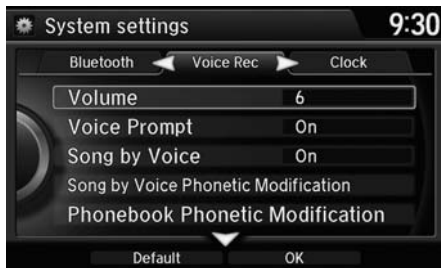

Rotate  to select an item. Press .

The following items are available:





- **Volume:** Adjusts the voice prompt volume level.
- **Voice Prompt:** Turns the voice prompt on or off.
On (factory default): Provides the voice prompts.
Off: Disable the feature.
- **Song by Voice:** Turns the Song By Voice™ on or off.
➤ **Song By Voice™ (SBV)** P. 184
- **Song by Voice Phonetic Modification:** Modifies a voice command of music stored in the HDD or an iPod®.
➤ **Phonetic Modification** P. 186
- **Phonebook Phonetic Modification:** Modifies a voice command for the phonebook.
➤ **Phonebook Phonetic Modification** P. 216

Display Settings

SETTINGS button ► **System Settings** ► **Display**

Adjusts the screen's preferences.



1. Rotate  to select an item. Press .
2. Rotate  to make the adjustment. Press .

The following items are available:

- **Brightness:** Adjusts the screen's brightness.
- **Contrast:** Adjusts the screen's contrast.
- **Black Level:** Adjusts the screen's black level.

Display Settings

You can set separate daytime and nighttime settings for **Brightness**, **Contrast**, and **Black Level**. Adjust each setting when the display is in either daytime or nighttime mode.

Sound and Beep Settings

🔗 SETTINGS button ▶ System Settings ▶ Sound/Beep

Changes the system sound and beep settings.

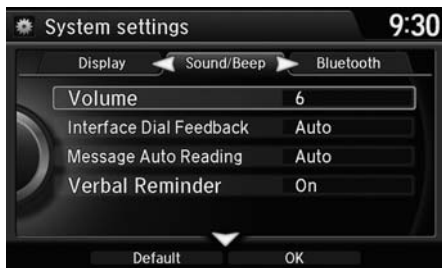

Rotate  to select an item. Press .

The following items are available:

- **Volume:** Adjusts the navigation system volume level.
- **Interface Dial Feedback:** Sets if and when the system reads aloud a selection made using the Interface Dial.
 - On:** Always reads the selection.
 - Off:** Disables the feature.
 - Auto** (factory default): Reads the selection only when the vehicle is moving.
- **Message Auto Reading:** Selects whether the system automatically reads out messages, and, if selected, whether only when driving.
 - On:** Always reads the message.
 - Off:** Disables the feature.
 - Auto** (factory default): Reads the message only when the vehicle is moving.
- **Verbal Reminder:** Turns the verbal reminders on and off.
 - On:** Sets the verbal reminders.
 - Off:** Disables the feature.

Sound and Beep Settings

Volume

If you set **Volume** to **0**, you will not hear route guidance or voice command confirmations.

If you then select **Voice** in the Map Menu, you will hear route guidance at the default volume.

Clock Adjustment

🔗 SETTINGS button ▶ System Settings ▶ Clock

Set the automatic adjustment of the system clock for daylight saving and international time zones.



Rotate 🌀 to select an item. Press 🕒.

The following items are available:

- **Clock/Wallpaper Type:** Changes the clock display type and the wallpaper type.
 ▶ **Setting the Clock Type** P. 28
- **Clock Adjustment:** Adjust the current time manually.
 ▶ **Setting the Clock** P. 28
- **Clock Format:** Sets the time notation to either 12-hour clock (12H, factory default) or 24-hour clock (24H).
- **Auto Time Zone:** The navigation system automatically adjusts the clock when driving through different time zones.
 On (factory default): Adjusts the clock automatically.
 Off: Disables the feature.
- **Auto Daylight:** The navigation system automatically adjusts the clock (“spring ahead” or “fall back” by one hour) when a daylight saving time change occurs.
 On (factory default): Adjusts the clock automatically.
 Off: Disables the feature.
- **Clock Reset:** Resets the settings of all items in the **Clock** group.

🔗 Clock Adjustment

Auto Time Zone

If you live and work in two different time zones, you may want to turn **Auto Time Zone** to **OFF**. When driving near a time zone boundary, the displayed time zone may fluctuate between the two zone times.

Auto Daylight

This function is not activated in areas that have not adopted daylight saving time, even if you have set **Auto Daylight** to **ON**.





You can turn the clock display in the navigation screen on and off.

▶ **Header Clock Display** P. 35

Setting the Clock Type

SETTINGS button ▶ **System Settings** ▶ **Clock** ▶ **Clock/Wallpaper Type** ▶ **Clock**





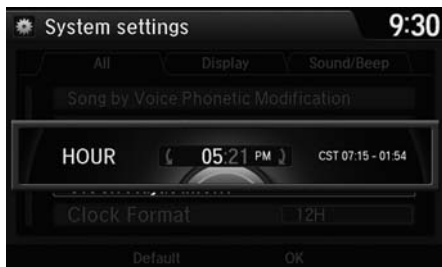

1. Rotate  to select an option to change the design. Press .
2. Move  to select OK. Press .

Setting the Clock

SETTINGS button ▶ **System Settings** ▶ **Clock** ▶ **Clock Adjustment**



1. Rotate  to select an item. Press .
2. Rotate  to select a minute. Press .

Wallpaper Settings

Select, delete, and import wallpaper pictures for display on the screen.

■ Import wallpaper

🔗 SETTINGS button ▶ **System Settings** ▶ **Clock** ▶ **Clock/Wallpaper Type**



1. Connect the USB flash drive to the USB port.
2. Move to select **Wallpaper**.
▶ The screen will change to the wallpaper list.
3. Move and rotate to select **Add New Wallpaper**. Press .
4. Rotate to select a desired picture. Press .
▶ The preview is displayed on the left side on the screen.
5. Move and rotate to select **Start Import**. Press .
▶ The confirmation message will appear. Then the display will return to the wallpaper list.



▣ Wallpaper Settings

- When importing wallpaper files, the image must be in the USB flash drive's root directory. Images in a folder cannot be imported.
- The file name must be fewer than 210 bytes.
- The file format of the image that can be imported is BMP (bmp) or JPEG (jpg).
- The individual file size limit is 6 MB.
- The maximum image size is 4,800 x 4,800 pixels. If the image size is less than 420 x 234 pixels, the image is displayed in the middle of the screen with the extra area appearing in black.
- Up to 10 files can be saved.
- If the USB flash drive does not have any pictures, the No files detected message appears.



Select wallpaper

SETTINGS button ▶ System Settings ▶ Clock ▶ Clock/Wallpaper Type ▶ Wallpaper



1. Rotate  to select a desired wallpaper. Press .
 - ▶ The preview is displayed on the left side on the screen.
 - ▶ The pop-up menu appears on the screen.



2. Rotate  to select **Set**. Press .
 - ▶ The display will return to the wallpaper list.

Select wallpaper

From the pop-up menu, rotate to select **Preview** and press to see a preview at full-size screen.







To go back to the previous screen, press to select **OK**, or press the **BACK** button.

When the file size is large, it takes a while to be previewed.

Delete wallpaper

SETTINGS button ▶ System Settings ▶ Clock ▶ Clock/Wallpaper Type ▶ Wallpaper



1. Rotate  to select a previously imported wallpaper that you want to delete. Press .
 - ▶ The preview is displayed on the left side on the screen.
 - ▶ The pop-up menu appears on the screen.
2. Rotate  to select **Delete**. Press .
 - ▶ The confirmation message will appear.
3. Rotate  to select **Yes**. Press .
 - ▶ The display will return to the wallpaper list.

Delete wallpaper



You cannot delete the factory default images.

Unit Settings

🔑 SETTINGS button ▶ **System Settings** ▶ **Others** ▶ **Units**

Sets the map units to either miles (factory default) or kilometers (km).



Rotate  to select the map unit.
Press .



Language Settings

SETTINGS button ▶ **System Settings** ▶ **Others** ▶ **Language**

Set the system language used on all screens. You can choose from three languages:

English, **Français** (French), **Español** (Spanish).



Rotate  to select the system language. Press .

Language Settings

Voice confirmation of cities and streets only occurs when **English** is the system language.



When **Français** or **Español** is selected, some messages continue to be displayed in English.

Background Color

🔑 SETTINGS button ▶ **System Settings** ▶ **Others** ▶ **Background Color**

Changes the background color of the navigation screen and the touchscreen.





Rotate  to select a desired color.
Press .

Header Clock Display

SETTINGS button ▶ **System Settings** ▶ **Others** ▶ **Header Clock Display**

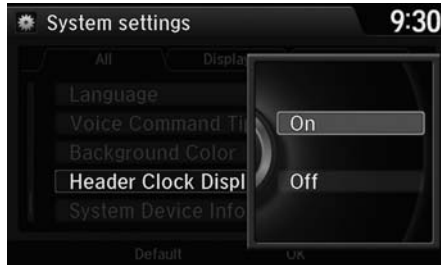
Selects whether the clock display comes on.



Rotate  to select an option. Press .

The following options are available:

- **On** (factory default): The system displays the clock in the navigation screen.
- **Off**: Disables the feature.

SETTINGS button ► Navi Settings ► Personal Info

Use the personal information menu to select and set your address books, home address, and PINs. You can also delete unwanted destinations from the list of previously routed destinations.

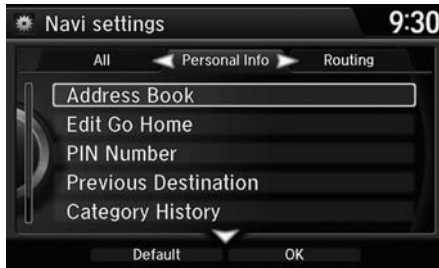

Rotate  to select an item. Press .

The following items are available:

- **Address Book:** Stores new addresses or edits your address book.
➤ **Address Book** P. 37
- **Edit Go Home:** Sets or edits your home address.
➤ **Home Address** P. 42
- **PIN Number:** Sets or changes your PIN.
➤ **PIN Numbers** P. 43
- **Previous Destination:** Deletes the destination history.
➤ **Previous Destination** P. 44
- **Category History:** Deletes the place categories you recently used.
➤ **Category History** P. 45
- **Download POI:** Edits and deletes the Imported POI categories.
➤ **Editing POI Categories** P. 47

Personal Information

Personal information cannot be backed up or moved to another navigation system.

Address Book

SETTINGS button ▶ **Navi Settings** ▶ **Personal Info** ▶ **Address Book**

Store up to 200 address entries in the address book. You can add, edit, and delete information in the address book.

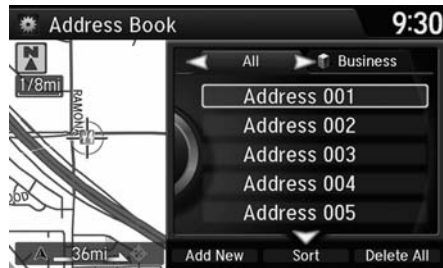

Move ◀ or ▶ to display only the addresses in the selected category.

Address Book

If you have PIN-protected your address book, enter your PIN when prompted. Press to select OK. PINs are optional.

▶ **PIN Numbers** P. 43

Any address book categories you create are also displayed.

▶ **Selecting an Address Book Category** P. 40

Adding an Address Book Entry

SETTINGS button ▶ **Navi Settings** ▶ **Personal Info** ▶ **Address Book**

This section explains how to enter the name and address.

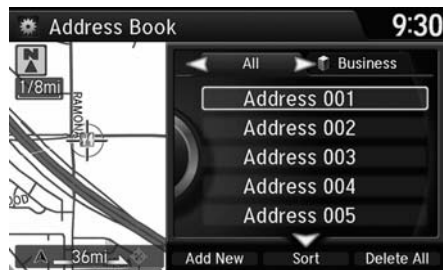



1. Move and rotate to select **Add New Address**. Press .

Adding an Address Book Entry

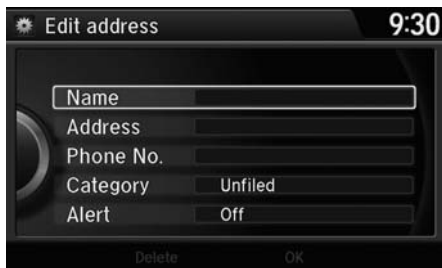
If you do not give the address a name, one is automatically assigned (e.g., Address 001). You can re-enter, edit, or make changes to any entry. "Address" is the only required field.





2. Rotate  to select an item. Press .



The following items are available:



- **Name:** Edits the name of the entry.
- **Address:** Edits the address of the entry.
- **Phone No.:** Edits the phone number of the entry.
- **Category:** Specifies the category of the entry.
- **Alert:** Alerts you when you approach the address entry.
On: Beeps and displays a message when your vehicle gets near the entry.
Off (factory default): Disables the feature.



3. Rotate  to select **Name**. Press .

4. Enter a name or title. Move  to select **OK**.

5. Rotate  to select **Address**. Press .

6. Rotate  to select an item for specifying the address. Press .

The following items are available:

- **Current Position:** Select your current location.
- **Address:** Enter an address on the character input screen when prompted.
 ➤ **Address** P. 86
- **Previous Destinations:** Select a previous destination.
 ➤ **Previous Destination** P. 93
- **Place Name:** Enter the name of a place/landmark.
 ➤ **Place Name** P. 96
- **Place Category:** Select a category to search for a place/landmark (e.g., Banking, Lodging).
 ➤ **Place Category** P. 94
- **More Search Methods:** Displays additional search method entries.
 ➤ **Entering a Destination** P. 84

Editing an Address Book Entry

SETTINGS button ▶ **Navi Settings** ▶ **Personal Info** ▶ **Address Book**



1. Rotate to select the address to edit. Press .
2. Enter the name, address, phone number, and category fields.
 ➤ **Adding an Address Book Entry** P. 37
3. Move and rotate to select OK. Press .

➤ Adding an Address Book Entry

When you use **Place Name** or **Place Category**, the phone number is automatically entered.

You can also add a phone number and category.

➤ Editing an Address Book Entry

The entered contents are displayed on the Edit address screen.

■ Selecting an Address Book Category

🔍 SETTINGS button ▶ **Navi Settings** ▶ **Personal Info** ▶ **Address Book**



1. Rotate 🔄 to select an address. Press ⏎.
2. Rotate 🔄 to select **Category**. Press ⏎.
3. Rotate 🔄 to select a category. Press ⏎.

▶ Create a category in advance.

📄 **Creating a New Category**
P. 40

■ Creating a New Category

1. Move 📍 and rotate 🔄 to select **New Category**. Press ⏎.
2. Enter a name and select an icon when prompted.
 - ▶ The created category is displayed in the list of categories.

■ Deleting or Editing a Category

1. Move 📍 and rotate 🔄 to select **Delete** or **Edit**. Press ⏎.
2. Delete an existing category, or change the name and icon.
 - ▶ The selected category to delete is indicated with a trash icon. Move 📍 and rotate 🔄 to select **OK**.

📄 Selecting an Address Book Category

You can have up to 100 categories (including "Unfiled").

If you delete a category that is used by other addresses, the category type for those addresses changes to "Unfiled."

■ Deleting an Address Book Entry

📍 SETTINGS button ▶ **Navi Settings** ▶ **Personal Info** ▶ **Address Book**

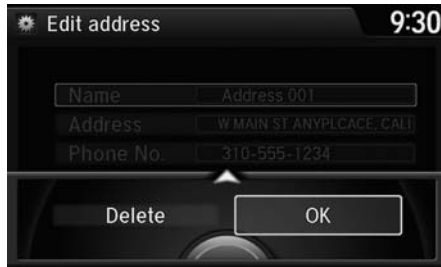

1. Rotate 🔄 to select the address to delete. Press 📍.
2. Move 📍 and rotate 🔄 to select **Delete**. Press 📍.
3. Rotate 🔄 to select **Yes**. Press 📍 to delete the address.

☒ Deleting an Address Book Entry

When you transfer the vehicle to a third party, delete all address book entries.

Home Address

📍 SETTINGS button ▶ **Navi Settings** ▶ **Personal Info** ▶ **Edit Go Home**

Set a home address that you frequently use.



1. Edit the name, address, and phone number the same way as an address in the address book.

➤ **Adding an Address Book Entry**
P. 37

2. Move 📍 and rotate 🔄 to select **OK**. Press 📍.

📁 Home Addresses

If you have PIN-protected your home addresses, enter your PIN when prompted. Press 📍 to select **OK**. PINs are optional.

➤ **PIN Numbers** P. 43

If your home street is not in the system database, park on the nearest verified street to your home. When entering the “Address” field, rotate 🔄 to select **Current Position** to use your current location as the home address and press 📍.

You can delete a home address if necessary. Move 📍 and rotate 🔄 to select **Clear Home Entry**. Press 📍. Rotate 🔄 to select **Yes**. Press 📍.

When you transfer the vehicle to a third party, delete all home addresses.

The home icon is shown on the map screen on the 1/20 and 1/8 mile scales.

PIN Numbers

🔗 SETTINGS button ▶ **Navi Settings** ▶ **Personal Info** ▶ **PIN Number**

Set a four-digit PIN for protecting personal addresses and your home address. Once you set a PIN, you are prompted to enter it whenever you access a personal address or a home address.



1. Rotate 🔄 to select the PIN to create. Press ⏹.



2. Rotate 🔄 to select a digit to enter. Press ⏹ to select **OK**. Repeat to enter a new four-digit PIN.

3. Re-enter the new PIN, when prompted, to confirm the number you just entered. Press ⏹ to select **OK**.

▶ If you have not entered the same number both times, an “INCORRECT PIN” message is displayed. Enter your PIN again.

🔗 PIN Numbers

PIN

Personal Identification Number (PIN) is a password used to access personal data.

PINs are optional. If you choose to use a PIN, keep a note of the number in a secure location. If you forget your PIN, a dealer will have to reset the navigation system and all of your stored information will be erased. The factory default is no PIN.

If you want to stop using a PIN, move 📍 to select **Turn off PIN entry**. Press ⏹.

Previous Destination

📍 SETTINGS button ▶ Navi Settings ▶ Personal Info ▶ Previous Destination

The navigation system maintains a list of your previously routed destinations as a shortcut for entering the same destination in the future. You can delete some or all of your previous destinations from the list.



Trash icon

1. Rotate 🔄 to select the destination to delete. Press 🗑️.
 - ▶ Repeat the procedure as necessary.
 - ▶ Items to be deleted are indicated with a trash icon.
2. Move 📍 and rotate 🔄 to select OK to delete the selected destinations.

Previous Destinations

Up to 50 destinations can be stored.

To cancel the selection of a previous destination, rotate 🔄 to highlight the destination again. Press 🗑️ to de-select it.

Category History

📍 SETTINGS button ▶ **Navi Settings** ▶ **Personal Info** ▶ **Category History**

The navigation system maintains a list of your recently used place categories as a shortcut for selecting the same categories in the future. You can delete some or all of your recently used categories from the list.

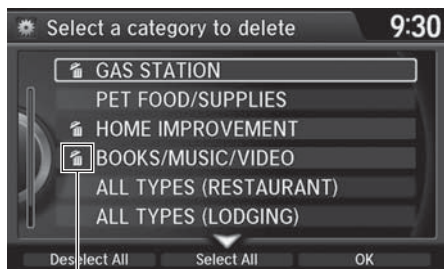

Trash icon

1. Rotate 📍 to select the category to delete. Press 🗑️.
 - ▶ Repeat the procedure as necessary.
 - ▶ Items to be deleted are indicated with a trash icon.

2. Move 📍 and rotate 📍 to select **OK** to delete the selected categories.

Category History

Up to 50 categories can be stored.

To cancel the selection of a category, rotate 📍 to highlight the category again. Press 🗑️ to de-select it.

Download POI

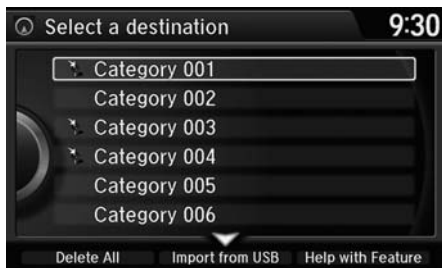

Import custom Points of Interest (POI) into the navigation system and set the POI as a destination. You can also add, edit, and delete POIs.

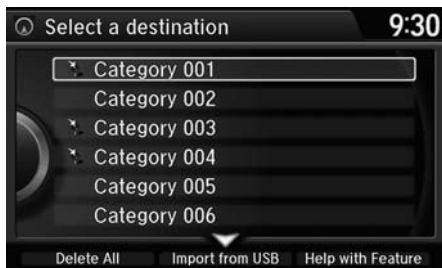

Importing POI Categories

MENU button (on map) ► **More Search Methods** ► **Download POI**



1. Connect a USB flash drive with stored POI data to the USB connector.
2. Move  and rotate  to select **Import from USB**. Press .

Importing POI Data



For more information about connecting a USB flash drive.

 **Connecting a USB Flash Drive** P. 193

POI data in csv and kml formats can be imported.

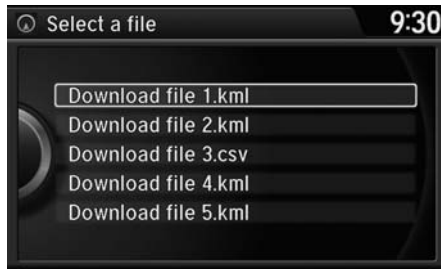
You can download POI data from various POI websites.





3. Rotate  to select a category to import. Press .

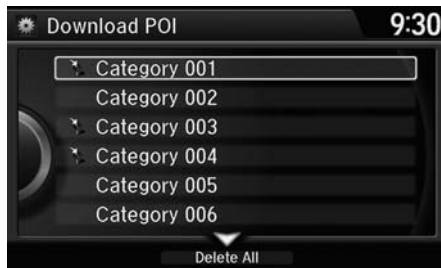

Editing POI Categories

 SETTINGS button ▶ **Navi Settings** ▶ **Personal Info** ▶ **Download POI**



1. Rotate  to select the downloaded POI category to edit. Press .



2. Rotate  to select an item. Press .

The following items are available:

- **Alert Setting:** Alerts you when you approach the places/landmarks in the category.
On: Beeps and displays a message when your vehicle gets near the places/landmarks in the category.
Off (factory default): Disables the feature.
- **Delete Category:** Deletes all places/landmarks and icon in the selected category.
- **Edit Icon:** Changes the category icon.

🔗 SETTINGS button ► **Navi Settings** ► **Routing**

Choose various settings that determine the navigation system functionality during route calculation.

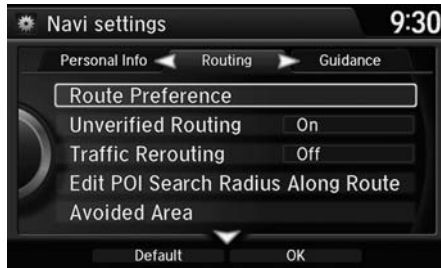

Rotate  to select an item. Press .

The following items are available:

- **Route Preference:** Changes the route preferences (calculating method).
➤ **Route Preference** P. 50
- **Unverified Routing:** Sets whether you use the route guidance in unverified areas.
➤ **Unverified Routing** P. 51
- **Traffic Rerouting:** Sets whether you use automatic recalculation based on traffic information.
➤ **Traffic Rerouting** P. 53
- **Edit POI Search Radius Along Route:** Sets the distance from the route to find waypoints.
➤ **Edit POI Search Radius Along Route** P. 54
- **Avoided Area:** Specifies areas to avoid when calculating a route.
➤ **Avoided Area** P. 55

Route Preference

📍 SETTINGS button ▶ Navi Settings ▶ Routing ▶ Route Preference

Change the route preference by selecting minimum or maximum driving methods.

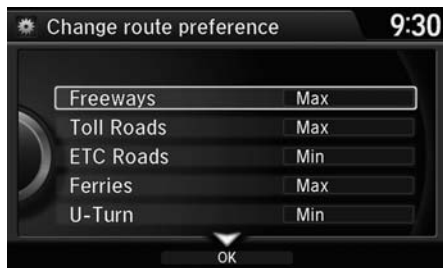

1. Rotate to select an item. Press .
2. Rotate to select **Min** or **Max**. Press .
 - ▶ Repeat step 1 and 2 as necessary.
3. Move to select **OK**. Press .

Route Preference

The calculated route may be the shortest route or the route you would choose. For safety reasons, the system generally applies the following rules to your route:

- Shortcuts through residential areas are avoided.
- Right turns are favored over left turns or U-turns.
- Time-restricted turns (turns prohibited at certain times of the day) are not used.

Check the ferry schedule when the calculated route includes ferry route.

ETC is short for the Electronic Toll Collection system.

Unverified Routing

🔗 SETTINGS button ► **Navi Settings** ► **Routing** ► **Unverified Routing**

Receive turn-by-turn map and voice guidance in unverified areas.



Rotate to select **On** or **Off**. Press .

Differences	Off	On (factory default)
On or Off?	The driver wishes to manually navigate using the navigation map and choose the streets that lead to the destination.	The driver chooses to let the navigation system suggest possible routing, knowing that the guidance may not be accurate.
Route calculation	Route is usually longer, using verified roads whenever possible.	Route is shorter, but uses unverified (purple) streets that may not be accurate.
Route line	The route line uses verified streets only (when possible). If Straight Line Guide is set to On , a pink vector line is displayed on the map that continually points to your destination. ➤ Straight Line Guide P. 73	A blue-pink route line highlights suggested unverified streets on the map while traveling to your destination.

Unverified Routing

Unverified roads are found in rural areas, and typically include residential streets away from the center of a town. They may not be accurate, and can contain errors in location, naming, and address range.

Unverified roads are shown only when viewing the map in the 1/20, 1/8, or 1/4 mile map scales.

Straight line guide

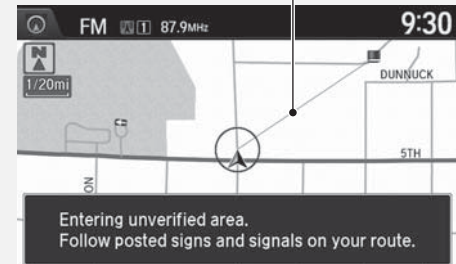

Blue-pink route line

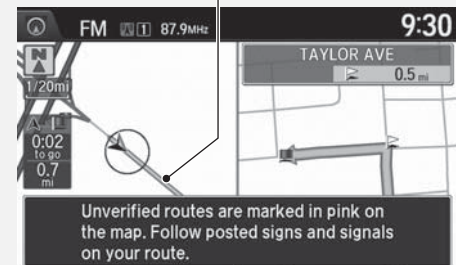

Differences	Off	On (factory default)
Cautionary messages	Cautionary pop-up screens and voice announcements remind you to obey all traffic restrictions when starting route guidance, approaching an unverified area, and entering an unverified street.	Cautionary pop-up screens and voice announcements remind you to obey all traffic restrictions when entering an unverified street.
Guidance (map/voice)	There is no turn-by-turn map or voice guidance.	Voice guidance commands end with the phrase “if possible” to remind you to verify all traffic restrictions.
Directions list	A direction list is typically not available. However, depending on your route, directions are provided to help you reach the first available verified road.	A direction list is provided showing street names and turn symbols in pink.



Traffic Rerouting

🔗 SETTINGS button ▶ **Navi Settings** ▶ **Routing** ▶ **Traffic Rerouting**

A faster route can be calculated based on continuously updated traffic information.

📄 **Traffic Rerouting™** P. 120



Rotate  to select an option. Press .

The following options are available:

- **On:** The system reroutes automatically based on traffic information.
- **Off** (factory default): Disables the feature.

☒ Traffic Rerouting

You must be in or near a traffic-enabled city to receive coverage for that area. FM Traffic is available in the lower 48 states and Hawaii.

Automatic traffic rerouting may not provide a detour route depending on circumstances.

Edit POI Search Radius Along Route





📍 SETTINGS button ▶ Navi Settings ▶ Routing ▶ Edit POI Search Radius Along Route

Select the distance from your highlighted route line (on either side of your route) that the system will search for a waypoint.

➤ Adding Waypoints P. 124

You can specify a different search distance for freeways and surface streets.



1. Rotate  to select an item. Press .
2. Rotate  to select a search distance. Press .

The following items are available:

- **On Freeways:** 1, 2, 5, or 10 miles can be set. Factory default is 2 miles.
- **On Surface Streets:** 1/2, 1, 2, or 5 miles can be set. Factory default is 1/2 mile.

Edit POI Search Radius Along Route

The search distance does not affect the search range used for the Find Nearest voice commands (e.g., say  "Find nearest gas station").

Avoided Area

SETTINGS button ► **Navi Settings** ► **Routing** ► **Avoided Area**

Specify up to five areas to avoid (e.g., road construction, closures), if possible, when the system calculates routes to your destination.



1. Move and rotate to select **New Area**, or rotate to select an existing area to edit.



2. Rotate to select **Name** to label the area to avoid. Press .
3. Enter a name or title. Move to select **OK**.
4. Rotate to select **Area** to define the area to avoid. Press .

The following options are available (after an area is set):

- **View Area:** Displays the selected avoid area on the map.
- **Delete:** Deletes the selected avoid area.

► Avoided Area

The maximum size of an “avoid area” is approximately 1 square mile.

If your selected area contains a freeway, you are asked “Do you want to avoid freeways?” Answering “No” allows you to use a route through an avoid area on a freeway without any pop-up messages.

You can select areas to avoid, however you cannot select roads or areas that you want the system to use for routing.



You can enter up to 25 characters for the name.

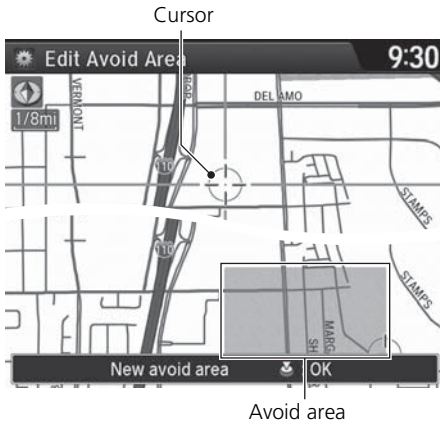

The following options are available:

- **Address:** Specify the general area by entering an address.
▶ **Address** P. 86
- **Map Input:** Specify the general area by map input.
▶ **Map Input** P. 105



5. Rotate  to select a method for specifying the area. Press .

6. If you select **Map Input**, scroll the map to position the cursor over your desired start point, adjusting the map scale as necessary. Press .

▶ To redo the area selection, press the BACK button.

7. Scroll the map to “draw” the area. Press .

8. Press  to select **OK**.

▶ The area you specify is displayed in the list of areas to avoid.

► Avoided Area

Avoid area can be set in the 1/20, 1/8, or 1/4 mile map scales.

SETTINGS button ► **Navi Settings** ► **Guidance**

Choose various settings that determine the navigation system functionality during route guidance.



Rotate  to select an item. Press .

The following items are available:

- **Guidance Mode:** Sets whether to display only the map screen or a split map-guidance screen.
➤ **Guidance Mode** P. 58
- **Street Name Guidance:** Sets whether to read out the street names during voice guidance.
➤ **Street Name Guidance** P. 60
- **Non-map screens** (models without LaneWatch): Sets whether the guidance screen interrupts the screen display.
➤ **Non-map screens** P. 61
- **Next Maneuver Pop Up** (models with LaneWatch): Sets whether to display the guidance information to the destination or the next waypoint.
➤ **Next Maneuver Pop up** P. 62
- **Guidance Point:** Sets whether to display the guidance information to the destination or the next waypoint.
➤ **Guidance Point** P. 63
- **Estimated Time:** Sets whether to display the remaining time or arrival time to the guidance point.
➤ **Estimated Time** P. 64

Guidance Mode

📍 SETTINGS button ▶ Navi Settings ▶ Guidance ▶ Guidance mode

Select the display mode for the map and guidance screens.



Rotate to select an option. Press .

The following options are available:

- **Map** (factory default): Displays only the map screen. When you approach a guidance point, the next guidance point appears.

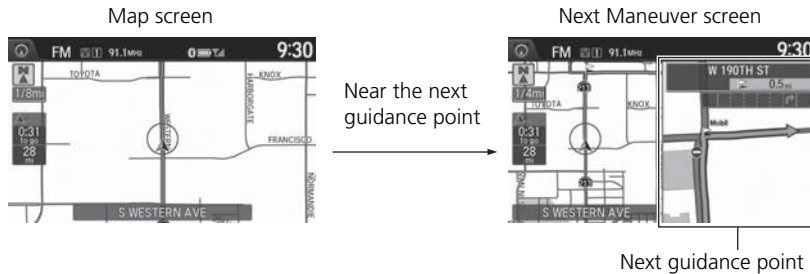

Guidance Mode

The guidance mode can also be selected from the map menu.

➤ **Map Menu** P. 116

Press the NAV button to switch between the map, next guidance direction, and a list of guidance directions.

- **Direction List:** Displays the map and direction list simultaneously on the map screen. When you approach a guidance point, the next guidance point appears.

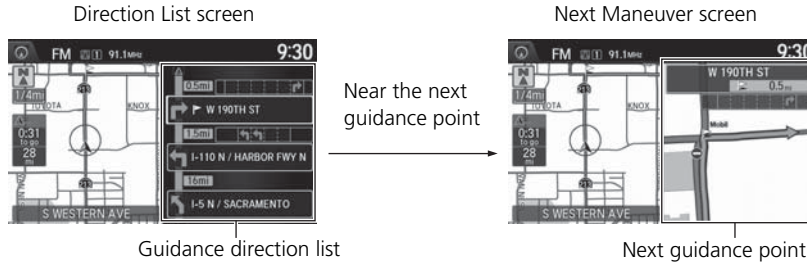

- **Next Maneuver:** Displays the map and next guidance point simultaneously on the map screen.

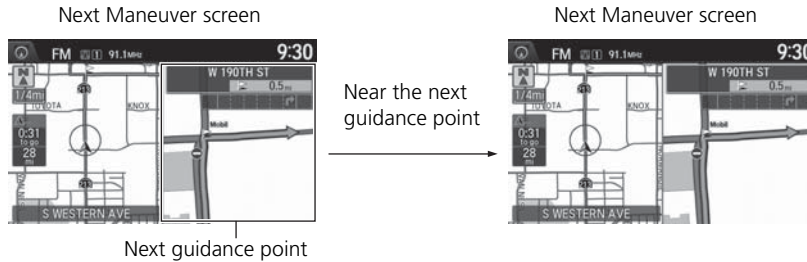



Street Name Guidance

📍 SETTINGS button ► **Navi Settings** ► **Guidance** ► **Street Name Guidance**

The navigation system includes the street names during voice guidance (e.g., “Turn right on Main Street”).



Rotate  to select an option. Press .

The following options are available:

- **On** (factory default): Voice guidance includes the street names.
- **Off**: Disables the feature.

Street Name Guidance

This feature is only available when the system language is set to **English**.

This feature may not be available in non-English speaking areas.

Models without LaneWatch

Non-map screens

🗺️ SETTINGS button ▶ **Navi Settings** ▶ **Guidance** ▶ **Non-map screens**

The navigation system temporarily interrupts the screen display to view the guidance screen as you approach a guidance point.



Rotate 🔄 to select an option. Press 🗺️.

The following options are available:

- **On**: The guidance screen interrupts other mode screens (e.g., audio, phone, etc, except the rear view camera mode).
- **Off** (factory default): Disables the feature.

Models with LaneWatch

Next Maneuver Pop up

📍 SETTINGS button ▶ **Navi Settings** ▶ **Guidance** ▶ **Next Maneuver Pop up**

The navigation system temporarily interrupts the screen display to view the guidance screen as you approach a guidance point.



Rotate  to select an item. Press .

The following items are available:



- **LaneWatch:** Sets whether to view the guidance screen while displaying the LaneWatch screen.
On (factory default): The guidance screen interrupts the LaneWatch screen.
Off: Disables the feature.
- **Non-map Screens:** Sets whether to view the guidance screen while displaying other mode (e.g., audio, phone, etc.) screen.
On: The guidance screen interrupts other mode screens (except the rear view mode).
Off (factory default): Disables the feature.

Guidance Point

🔧 SETTINGS button ▶ **Navi Settings** ▶ **Guidance** ▶ **Guidance Point**

Set the guidance point to display on the map screen.



Rotate  to select an option. Press .

The following options are available:



- **Destination** (factory default): Displays the remaining/arrival time and distance to the destination.
- **Next Point**: Displays the remaining/arrival time and distance to the next waypoint.

Estimated Time

🔑 SETTINGS button ▶ **Navi Settings** ▶ **Guidance** ▶ **Estimated Time**

Select the estimated time to display on the screen.



Rotate  to select an option. Press .

The following options are available:

- **Arrival**: Displays the arrival time to the destination or the next waypoint.
- **Remaining** (factory default): Displays the remaining time to the destination or the next waypoint.

SETTINGS button ► **Navi Settings** ► **Map**

Select the landmark icons to display on the map, change the orientation of the map, display your current location, and learn the meaning of the icons, colors, and symbols displayed on the map.

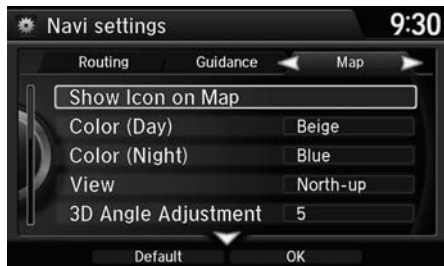

Rotate  to select an item. Press .

The following items are available:

- **Show Icon on Map**: Selects the icons to display on the map.
➤ **Showing Icons on Map** P. 67
- **Color (Day)**: Selects the color of the map for the Day mode.
➤ **Color** P. 69
- **Color (Night)**: Selects the color of the map for the Night mode.
➤ **Color** P. 69
- **View**: Selects the map orientation (North-up, Heading-up, or 3D map).
➤ **View (Map Orientation)** P. 72
- **3D Angle Adjustment**: Adjusts the viewing angle for the 3D map.
➤ **3D Angle Adjustment** P. 73
- **Straight Line Guide**: Sets whether to display a straight guideline to the destination or waypoint.
➤ **Straight Line Guide** P. 73

- **Current Location:** Displays and saves your current location.
▶ **Current Location** P. 74
- **Map Legend:** Displays an overview of the map features.
▶ **Map Legend** P. 75
- **Display Tracking:** Sets whether to display the tracking dots on the map.
▶ **Display Tracking** P. 79
- **Delete Tracking:** Deletes the tracking dots on the map.
▶ **Deleting Tracking Dots** P. 79
- **Correct Vehicle Position:** Adjusts the position of the vehicle on the map.
▶ **Correct Vehicle Position** P. 80
- **System Device Information:** Views database, software, device, and vehicle identification information.
▶ **System Device Information** P. 272
- **Map Data Update:** Checks the map data update status when updating the map database.
▶ **Map Data Update** P. 272

Showing Icons on Map

🗺️ SETTINGS button ▶ **Navi Settings** ▶ **Map** ▶ **Show Icon on Map**

Select the icons that are displayed on the map.



1. Rotate 🔄 to select an item. Press 🗺️.



2. Rotate 🔄 to select an option. Press 🗺️.

▶ Repeat step 1 and 2 as necessary.

3. Move 🗺️ to select OK. Press 🗺️.

The following options are available:

- **All On:** Displays the landmark icons.
▶ **Map Screen Legend** P. 9
- **Customize:** Fine-tunes the icon display.
▶ **Fine-tuning the Icons** P. 68
- **Off:** Hides the landmark icons.

▶▶ Showing Icons on Map

You can display or hide the icons using voice commands on the Voice Portal screen (e.g., say 🗺️ "Display hospital").

▶ **Map Display Commands** P. 308



If you have PIN-protected your address book, enter your PIN when prompted. Move 🗺️ to select **OK**. PINs are optional.

▶ **PIN Numbers** P. 43



Fine-tuning the Icons

Icons in some categories can be fine-tuned to display or hide.



1. Rotate  to select the icons to display on the map. Press .

- ▶ Pressing  toggles the icon display on or off.
- ▶ Repeat the procedure as necessary.

2. Move  and rotate  to select OK. Press .

Color

Set separate map colors for Day and Night modes.

■ Color (Day)

SETTINGS button ▶ Navi Settings ▶ Map ▶ Color (Day)

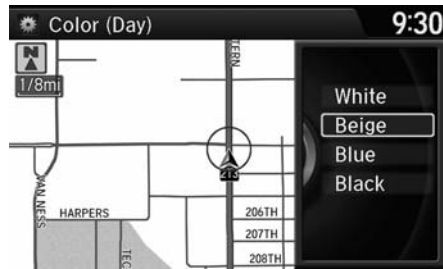

Rotate to select a color for the Day mode. Press .

■ Color (Night)

SETTINGS button ▶ Navi Settings ▶ Map ▶ Color (Night)

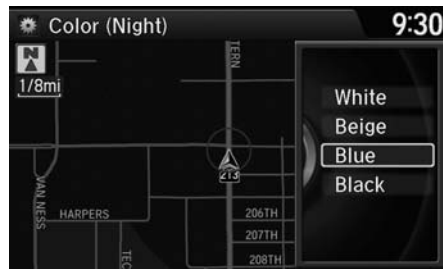

Rotate to select a color for the Night mode. Press .

» Color (Day)

Set to **White** (factory default is **Beige**) to obtain the best daytime display contrast.





» Color (Night)

Set to **Black** (factory default) to obtain the best nighttime display contrast.

Switching Display Mode Manually

Set the screen brightness separately for Day and Night modes. Press the  (Display mode) button to cycle through the display modes (Day to Night to Off).



1. Press the  button.
 - ▶ The Brightness bar is displayed for a few seconds.
 - ▶ Rotate  to adjust the brightness. Press .
2. Press the  button again.
 - ▶ Repeat the procedure to switch the display modes.



Switching Display Mode Manually

A visual guide helps you see the difference between Day and Night modes.

 **Day or Night Mode** P. 10

Recommended Settings

- Select mid-range for the dash illumination.
- Select **White** for the map Day display and **Black** for the map Night display.



Illumination control	Priority	Operation
 button	1	Selects Day, Night, or Off display mode. This button has the highest priority and overrides all other display control adjustments listed below. Remember: Once you press this button, you assume full manual control of the display mode until the power mode is set to VEHICLE OFF (LOCK).
Sunlight sensor (see your Owner's Manual for location)	2	If the sunlight sensor detects daylight and the headlights are turned on, the system automatically overrides the Night display and displays the Day display mode. Remember: If desired, use the  button to override this automatic choice.
Dash illumination adjustment buttons (see your Owner's Manual for location)	3	When headlights are turned on, and you wish to have the Day display mode, adjust the illumination to the full brightness setting (beeps). Remember: Adjust the dash brightness back to mid-range to allow auto switching by sensing the headlights are on or off.
Headlights (Auto/On/Off)	4	When turned on, the display changes to Night display mode. The previous three controls listed above can "cancel" this function. Remember: Use the  button, or adjust the dash illumination to full brightness, to set the display to your desired choice.
Screen color choice	N/A	The user can select the color of the screen that will be displayed for the Day and Night display modes described above. Remember: For best contrast, ensure that the map color is white for Day and black for Night.

View (Map Orientation)

📍 SETTINGS button ▶ Navi Settings ▶ Map ▶ View

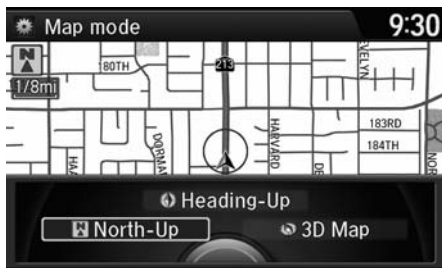
Select the map orientation.





Rotate  to select an option. Press .

The following options are available:

- **North-Up:** Displays the map with North always pointing up.
- **Heading-Up:** Displays the map so that the direction you are traveling is always pointing up.
- **3D Map:** Displays the bird's eye view map.

View (Map Orientation)

 "Display Heading-up" (on Voice Portal screen),  "Display North-up" (on Voice Portal screen),  "Display 3D map" (on Voice Portal screen)

The red arrow in the symbol always points North.

Heading-up and 3D map view switch to the North-up view on the maximum map scale.

The bird's eye view map switches to the Heading-up map while scrolling the map.

The viewing angle for the bird's eye view can be adjusted.



 **3D Angle Adjustment** P. 73

3D Angle Adjustment

SETTINGS button ▶ Navi Settings ▶ Map ▶ 3D Angle Adjustment

Adjust the viewing angle.





Rotate  to adjust the angle. Press .

Straight Line Guide

SETTINGS button ▶ Navi Settings ▶ Map ▶ Straight Line Guide

Set whether to display a straight guideline to the destination or waypoint



Rotate  to select an option. Press .

The following options are available:

- **On** (factory default): Displays the straight guideline on the map.
- **Off**: Disables the feature.

Current Location

📍 SETTINGS button ▶ **Navi Settings** ▶ **Map** ▶ **Current Location**

Display and save your current location for future use as a destination. The address, latitude, longitude, and elevation of your current location are displayed.

■ To save your current location in the address book:

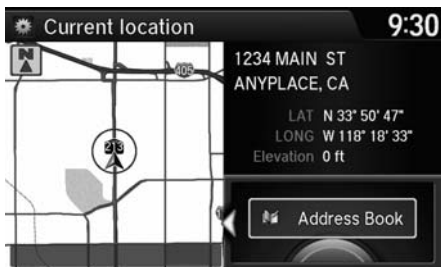

1. Press 📍 to select **Address Book**.

▶ Move ⏪ to scroll the map as necessary.



2. Edit the name, phone number, and category.

➡ **Address Book** P. 37

3. Move 📍 and rotate 🔄 to select **OK**. Press 📍.

🗨️ Current Location

🗨️ *“Display Current Location”* (on Voice Portal screen)

You can also save the current location by saying 🗨️ *“Register the Current Location”*.

If you have PIN-protected your address book, enter your PIN when prompted. Press 📍 to select **OK**. PINs are optional.

➡ **PIN Numbers** P. 43

The elevation is not displayed if the system is receiving insufficient GPS information. When elevation is displayed, it may differ with roadside elevation signs by ±100 feet or more.

Saving your current location does not change or cancel your current route.

Map Legend

⚙️ SETTINGS button ▶ **Navi Settings** ▶ **Map** ▶ **Map Legend**

See an overview of the map lines, areas, routes, traffic information, and navigation icons.



Move ◀○ or ○▶ select an item.

▶ The system displays the map legend.

Map Legend

A visual guide helps you see the map legend.

▶ **Map Screen Legend** P. 9

■ Map Scale and Functions

The functions that are available from the map screen depend on the map scale.

Function	page	Map Scale (top: mile, bottom: metric)											
		1/20	1/8	1/4	1/2	1	2	5	15	50	150	350	1000
		80	200	400	800	1.6	3.2	8	24	80	240	560	1600
Icon display													
Landmark icon	9	✓	✓										
Exit info.	9			✓	✓	✓							
One-way traffic	9	✓											
Waypoint "flag"	10	✓	✓	✓	✓	✓	✓	✓	✓	✓	✓	✓	✓
Traffic incident	9	✓	✓	✓	✓	✓	✓	✓					
Map orientation													
Heading-up	72	✓	✓	✓	✓	✓	✓	✓	✓	✓	✓	✓	
North-up	72	✓	✓	✓	✓	✓	✓	✓	✓	✓	✓	✓	✓
3D map	72	✓	✓	✓	✓	✓	✓	✓	✓	✓	✓	✓	
Others													
Tracking dots	113	✓	✓	✓	✓								
Unverified road	9	✓	✓	✓	✓	✓	✓						
Map features	9	✓	✓	✓	✓	✓	✓	✓	✓	✓	✓	✓	✓
Avoid areas	55	✓	✓	✓									
Traffic speed	9	✓	✓	✓	✓	✓	✓	✓					

▣ Map Scale and Functions

You can change the map scale using voice commands on the Voice Portal screen (e.g., say  "Display 2 mile scale").

 **Map Scale Commands** P. 308

You can change between miles or kilometers.

 **Unit Settings** P. 32

■ Map Icons and Functions

Display or hide all icons on the map screen, with the exception of Honda/Acura Dealer icons which are always shown.

■ Landmark icon

Type	Icon display control	Icon selectable	Icon searchable
Honda/Acura dealer	Always on	Yes	Yes
Hospital	Yes	Yes	Yes
School	Yes	Yes	Yes
ATM	Yes	Yes	Yes
Gas station	Yes	Yes	Yes
Restaurants	Yes	Yes	Yes
Post office	Yes	Yes	Yes
Grocery store	Yes	Yes	Yes
Hotel/Lodging	Yes	Yes	Yes
Police station	No icon	No	Yes
Shopping, Tourist attraction, Bank	No icon	No	Yes
Parking garage	Yes	Yes	Yes
Parking lot	Yes	Yes	Yes
Freeway exit info.	Yes	Yes	No

▣ Map Icons and Functions

You can display or hide the icons using voice commands on the map screen (e.g., say  "Display hospital").

▣ Map Display Commands P. 308

Some icons, like police stations, are not shown, but you can still locate the nearest one with the Find Nearest voice command (e.g., say  "Find nearest police station").

▣ Find Place Commands P. 309

Icon display control

Icons that can be displayed or hidden using the Interface Dial or voice command.

Icon selectable

Icons that can be selected as a destination using the Interface Dial.

Icon searchable

Icons that can be searched using the  Find Nearest voice command.

■ Traffic icon

Type	Icon display control	Icon selectable	Icon searchable
Traffic incident	Yes	No	Yes

☒ Traffic Incident

When you use the Interface Dial to position the cursor (round red circle) over the traffic incident icon, you can view the summary of the incident.

Press  on the traffic incident icon to view a pop-up message describing the incident in detail.

Display Tracking

SETTINGS button ▶ **Navi Settings** ▶ **Map** ▶ **Display Tracking**

The navigation system can be set to display white tracking dots (“breadcrumbs”) on the map screen.



Rotate to select an option. Press .

The following options are available:

- **On:** The system displays the white tracking dots.
Tracking Dots P. 113
- **Off** (factory default): Disables the feature.

Deleting Tracking Dots

SETTINGS button ▶ **Navi Settings** ▶ **Map** ▶ **Delete Tracking**



Rotate to select **Yes**. Press .

Deleting Tracking Dots





When you transfer the vehicle to a third party, delete the tracking dots.

Correct Vehicle Position

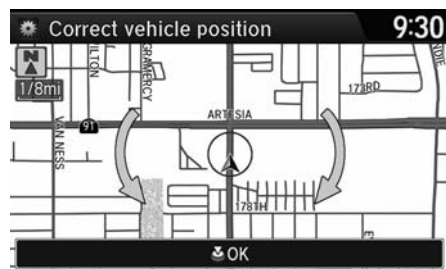
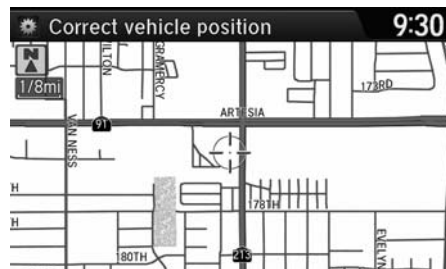
📍 SETTINGS button ▶ Navi Settings ▶ Map ▶ Correct Vehicle Position

Manually adjust the current position of the vehicle as displayed on the map screen if the position appears to be incorrect.



1. Put the vehicle in Park.
2. Rotate  to select **Correct Vehicle Position**. Press .
3. Scroll the map to position the cursor over at your correct position. Press .
4. Rotate  to position the arrowhead in the correct direction the vehicle is facing.
5. Press  to select OK.

✉ Correct Vehicle Position

An apparent position error can occur where buildings, tunnels, and other objects block or reflect the GPS signals, forcing the system to use “dead reckoning” to determine your location and direction.

Using this function to adjust vehicle position is not recommended. When the system reacquires a GPS signal, it will automatically place the vehicle in the correct location.

If you continually have to adjust the vehicle position, you may have problems with the GPS reception or there may be database errors.



➤ **System Limitations** P. 294

Defaulting All the Settings

SETTINGS button ► System Settings ► Others ► Factory Data Reset

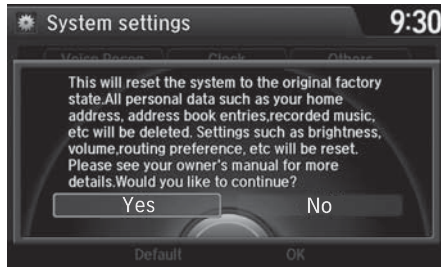
Reset all the menu and customized settings as the factory defaults.



1. Rotate  to select **Yes**. Press .
 - The confirmation message will appear.
2. Rotate  to select **Yes**. Press again to reset the settings.
 - The confirmation message will appear. Press to select **OK**.

Defaulting All the Settings

When you transfer the vehicle to a third party, reset all settings to default and delete all personal data.

The following settings will be reset:

- Routing & Guidance: Rerouting, Unverified Area Routing, Traffic Rerouting, Edit Waypoint Search Area, Guidance Mode, Street Name Guidance
- Route Preference

Changing the Screen Settings

Adjusts the screen settings of the touchscreen.



1. Select **More**.
2. Select **Screen Settings**.
3. Use **+**, **-** or other icons to adjust the setting.

The followings are adjustable screen settings:

- **Brightness:** Adjusts the screen's brightness.
- **Contrast:** Adjusts the screen's contrast.
- **Black Level:** Adjusts the screen's black level.
- **Display:** Changes between the daytime or nighttime modes.
- **Beep:** Sounds a beep every time you touch the screen.
- **Fade Timer:** Sets the screen black out timing.

Changing the Screen Settings

Select **X** to go back to the previous screen.

Use the **◀▶**/**⏪⏩**/**⏴⏵** icons to turn the page.

Navigation



This section describes how to enter a destination, select a route to take, and follow the route to your destination. It also describes how to change your route or destination along the way.

Entering a Destination	84	Calculating the Route	108	Editing the Destination List	128
Address	86	Viewing the Routes	109	Taking a Detour	130
Address Book	92	Driving to Your Destination	110	Avoiding Streets	130
Previous Destination	93	Viewing the Route	110	Changing Your Destination	131
Place Category	94	Listening to Voice Guidance	114	Find Nearest Place	131
Place Name	96	Reaching a Waypoint	115	Selecting a Destination on the Map	132
Place Phone Number	99	Map Menu	116	Entering a New Destination	133
ZAGAT	99	Displaying the Map Menu	116	Resuming Your Trip	134
Download POI	102	Directions	118		
Scenic Route	103	Traffic Rerouting™	120		
Intersection	104	Changing Your Route	122		
Map Input	105	Pausing the Route	123		
Coordinate	107	Canceling the Route	123		
		Adding Waypoints	124		

Entering a Destination

 MENU button (on map)

This section describes how to enter a destination for route guidance.



Rotate  to select an item. Press .



► Select **More Search Methods** to display additional menu entries.



The following items are available:

- **Address:** Sets a destination by entering an address.
➤ **Address** P. 86
- **Address Book:** Sets a destination by selecting an address stored in your Address Book.
➤ **Address Book** P. 92
- **Previous Destination:** Sets a destination by selecting a previous destination.
➤ **Previous Destination** P. 93

Entering a Destination

 "Display Destination",  "Display Navigation"

If you press the MENU button when en route, the Route Option screen is displayed.

➤ **Changing Your Route** P. 122

Prior to departure, you can set areas along your route to avoid.

➤ **Avoiding Streets** P. 130

- **Go Home:** Sets your home address as a destination.
📄 **Going Home** P. 11
- **Place Category:** Sets a destination by selecting a place/landmark.
📄 **Place Category** P. 94
- **Place Name:** Sets a destination by entering a place name.
📄 **Place Name** P. 96
- **Place Phone No.:** Sets a destination by entering the phone number of a place/landmark.
📄 **Place Phone Number** P. 99
- **ZAGAT:** Sets a destination (restaurant) by using ZAGAT® SURVEY Rating information.
📄 **ZAGAT** P. 99
- **Download POI:** Sets a destination by using a list of the imported POI (category and places) data you created.
📄 **Download POI** P. 102
- **Scenic Route:** Sets a destination by using a list of scenic roads for each state (U.S. and Canada only).
📄 **Scenic Route** P. 103
- **Intersection:** Sets a destination (intersection) by entering two streets.
📄 **Intersection** P. 104
- **Map Input:** Sets a destination by scrolling through the map.
📄 **Map Input** P. 105
- **Coordinate:** Sets a destination by entering latitude and longitude.
📄 **Coordinate** P. 107

📄 Entering a Destination

ZAGAT provides restaurant information only in the U.S.

Address





MENU button ▶ **Address**

Enter an address to use as the destination. The state or province you are currently in is displayed (e.g., California).



Rotate  to select an item. Press .



The following items are available:

- **City:** Selects your destination city.
 **Selecting a City** P. 88
- **Street:** Selects your destination street.
 **Selecting a Street** P. 89
- **House Number:** Enters the house number to select the street.
 **Selecting a Street by House Number** P. 91
- **ZIP Code:** Enters the zip code to select the city.
 **Selecting a City by Zip Code** P. 87
- **Change State:** Selects the state or province.
 **Selecting the State or Province** P. 87

■ Selecting the State or Province

MENU button ▶ **Address** ▶ **Change State**





Rotate  to select a state from the list. Press .



■ Selecting a City by Zip Code

MENU button ▶ **Address** ▶ **ZIP Code**



1. Enter the zip code of your destination.
2. Move  to select OK. Press .

▣ Selecting the State or Province



Move  or  to select the following areas:

- USA for the U.S. mainland, Alaska, Hawaii, and Puerto Rico
- Canada
- Mexico

▣ Selecting a City by Zip Code

If your city is not listed, it may be part of a larger metropolitan area. Try entering the street first.



3. Rotate  to select the destination city from the list. Press .

▶ Next, you are prompted to enter a street name.



➤ **Selecting a Street** P. 89

Selecting a City

 MENU button ▶ **Address** ▶ **City**

The name of the city where you are currently located is displayed.



1. Enter the name of a different city, or move  to select **OK** for the current city. Press .

Selecting a City

Vehicle position may not be displayed when:

- The automobile is traveling off-road.
- The vehicle position data cannot be updated.

You do not need to enter spaces or symbols (e.g., &, -, %). Partial matches are supported (e.g., "ANGELES" to find "LOS ANGELES").

Using Voice Command (English only)

Say  "City" on the Find address by screen, and the following screen is displayed:





- Say  "Current City" to select your current location, or say the name of a different city.

➤ **Selecting a Street** P. 89

- The Say city name screen is not displayed when your vehicle is in Puerto Rico or Mexico.



Non-detailed area mark: Try entering the street first and then select the city.

2. Rotate  to select your destination city from the list. Press .

- ▶ A list of matching hits is automatically displayed after you enter several letters, with the closest match at the top of the list. Matching letters are highlighted.
- ▶ Next, you are prompted to enter a street name.

➤ **Selecting a Street** P. 89

➤ **Selecting a City**

If your city is not listed, it may be part of a larger metropolitan area. Try entering the street first.

➤ **Selecting a Street**

When entering the names of major freeways, you can use the following abbreviations. For interstates, use an "I" (e.g., I-10). For U.S. freeways, use "US" (e.g., US-18). For state freeways, use the two-character state designation (e.g., CA-101). For county roads, use the appropriate designation (e.g., G-2).

Using Voice Command (English only)

Say  "Street" on the Find address by screen, and the following screen is displayed:

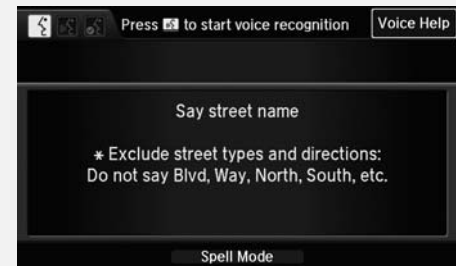



- Say the name of your destination street, and say the street number as a string of individual numbers.
- Set the route to your destination.
- **Calculating the Route** P. 108
- The Say street name screen is not displayed when your vehicle is in Puerto Rico or Mexico.

Selecting a Street

 MENU button ▶ **Address** ▶ **Street**





1. Enter the name of your destination street.

- ▶ Do not enter the street type (e.g., street, road, avenue) or direction (e.g., north, south, east, west).
- ▶ Move  to select **OK** to display a list of streets. Press .

Continued



2. Rotate  to select your destination street from the list. Press .

▶ A list of matching hits is automatically displayed after you enter several letters, with the closest match at the top of the list. Matching letters are highlighted.

3. Enter the street number.

▶ Only valid street numbers can be entered.

4. Move  to select OK. Press .



5. Set the route to your destination.

➤ **Calculating the Route** P. 108

▶ Selecting a Street

If you did not select a city first and there is more than one city with the specified street, a list of cities is displayed.







Rotate  to select the desired city from the list. Press .

■ Selecting a Street by House Number

 MENU button ▶ **Address** ▶ **House Number**



1. Enter the house number.
 - ▶ Only a valid house number can be entered.
2. Move  to select **OK**. Press .
 - ▶ If you did not yet select a street name, enter a street name when you are prompted.
3. Rotate  to select your destination street from the list. Press .
 - ▶ Select a city when you are prompted.
4. Set the route to your destination.
 - ▶  **Calculating the Route** P. 108

Address Book

📍 MENU button ► **Address Book**

Select an address stored in your address book to use as the destination.

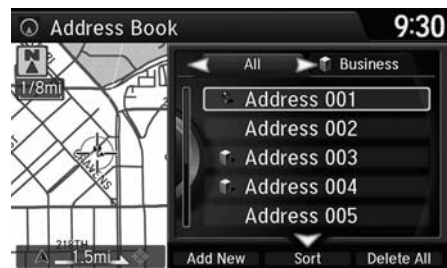

1. Rotate 🔄 to select your destination from the list. Press 📍.

2. Set the route to your destination.

➤ **Calculating the Route** P. 108

► Move ◀○ or ○▶ to display only the entries in the categories you have created.

➤ **Selecting an Address Book Category** P. 40

✉ Address Book

If you have PIN-protected your address book, enter your PIN when prompted. Press 📍 to select OK. PINs are optional.

➤ **PIN Numbers** P. 43

Move 📍 and rotate 🔄 to select the following items:



- **Add New Address:** Adds an entry to the address book.
- **Adding an Address Book Entry** P. 37
- **Sort:** Selects Sort by Name or Sort by Distance.
- **Delete All:** Deletes all entries in the address book.

Previous Destination

MENU button ▶ Previous Destination

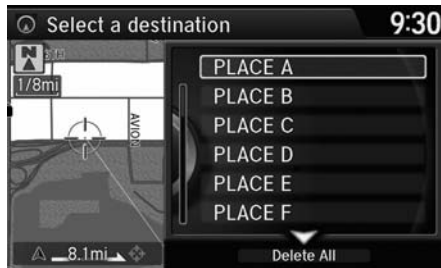
Select an address from a list of your 50 most recent destinations to use as the destination. The list is displayed with the most recent destination at the top.





1. Rotate  to select a destination from the list. Press .
2. Set the route to your destination.
 **Calculating the Route** P. 108

▶ Previous Destination

If **Previous Destination** is grayed out, there are no previous destinations entered.

Your home address and addresses stored in your address book are not added to the list of previous destinations.

Move  and rotate  to select **Delete All** to delete all previous destinations.

You can delete unwanted previous destinations from the list.



 **Previous Destination** P. 44

Place Category



MENU button ▶ Place Category

Select the category of a place (e.g., Banking, Lodging, Restaurant) stored in the map database to search for the destination.



1. Rotate  to select a category.
Press .



2. Rotate  to select a subcategory.
Press .

 **List of Categories** P. 320

Place Category

This option is convenient if you do not know the exact name of a place or if you want to narrow down the number of matches returned for places with a common name.



Move  to select **Category History** to access your recently used place categories. Up to 30 categories can be stored.

You can also delete your recently used place categories.

 **Category History** P. 45

Search POI Categories helps you to search the subcategory. When you enter a keyword and select **OK**, the list of appropriate subcategories is displayed.





3. Rotate  to select an item. Press .

The following items are available:

- **Search by Name:** Searches for a place in the subcategory by name. Enter a city name when prompted.
- **City Vicinity:** Searches for a place in the subcategory within a 20-mile radius of a specific city. Enter a city name and then a place name when prompted. Only the first 1000 matching places/landmarks are displayed.
- **Sort by Distance to Travel:** Displays all the places in the subcategory sorted by distance from your current location. The closest place is displayed at the top.



4. Rotate  to select a place name from the list. Press .

5. Set the route to your destination.
 ▶ **Calculating the Route** P. 108

▶▶ Place Category

The straight line distance (as the crow flies, not driving distance) and direction to the destination are shown for the highlighted place.

Restaurants with a **Z** icon have a ZAGAT® review. To display only restaurants with a ZAGAT® review, move  to select **ZAGAT Only**.

▶ **ZAGAT Review** P. 101

ZAGAT provides restaurant information only in the U.S.

Place Name

📍 MENU button ► Place Name

Enter the name of a place (e.g., business, hotel, restaurant) stored in the map database to use as the destination.



1. Enter a place name.
2. Move 📍 to select **OK** to display a list of matching hits. Press 🗑️.

3. Rotate 🔄 to select a place name from the list. Press 🗑️.

► If the place name is in multiple categories, the categories are displayed when you select it.
 ➤ **Place Name in Multiple Categories** P. 97

4. Set the route to your destination.
 ➤ **Calculating the Route** P. 108

☒ Place Name

This option is convenient if you know the exact name of a place.

Once a name is entered and selected, move 📍 to select **Sort by Name** or **Sort by Distance**. Matching letters are highlighted.

Restaurants with a **Z** icon have a ZAGAT® review.



➤ **ZAGAT** P. 99

ZAGAT provides restaurant information only in the U.S.

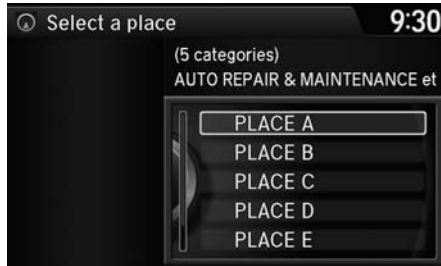

■ Place Name in Multiple Categories

If the place name is in multiple categories in the map database, the following screen is displayed.

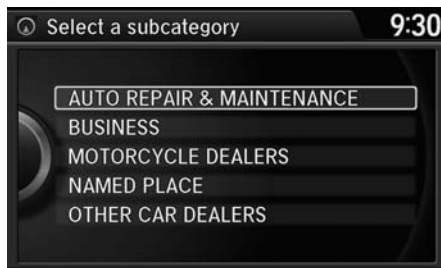

1. Rotate  to select a place name.
Press .





2. Rotate  to select a subcategory.
Press .

☒ Place Name in Multiple Categories

Matching letters are in highlighted.



3. Rotate  to select a place. Press .
4. Set the route to your destination.
▶ **Calculating the Route** P. 108

▶ Place Name in Multiple Categories



Move  to select **Sort by City** or **Sort by Distance**.

Place Phone Number

MENU button ▶ **More Search Methods** ▶ **Place Phone Number**

Select a destination by phone number. Only phone numbers in the database are recognized.



1. Enter the area code and phone number.
2. Rotate  to select OK. Press .
3. Set the route to your destination.
 **Calculating the Route** P. 108

ZAGAT

MENU button ▶ **More Search Methods** ▶ **ZAGAT**

Find a restaurant by ZAGAT® SURVEY Rating information.

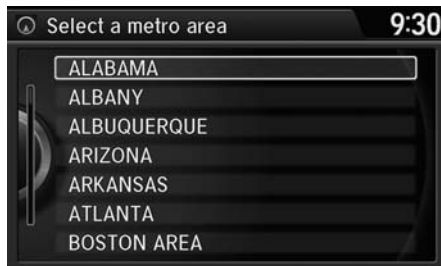



1. Select a metropolitan area, region, neighborhood, and restaurant type when prompted.

Place Phone Number

All 10 digits must be entered.

Phone numbers of private residences entered in your address book are not stored in the database and thus cannot be used to search for a destination.

A list is displayed if there are multiple locations in the database with the same phone number.

Rotate  to select a place from the list. Press .



ZAGAT®

Selecting this sorting method will show you ZAGAT's highest-rated restaurants by the options, and not necessarily by distance from your current location.

Only states within the U.S. are displayed in the metropolitan area list.

Restaurant information for Mexico cannot be searched with ZAGAT.





2. Rotate  to select the sort method used to list the restaurants. Press .

The following options are available:

- **Food, Décor, Service:** Lists the restaurants by the rating value.
- **Cost:** Lists the restaurants by the average cost of a meal (including drink and tip).



3. Rotate  to select a restaurant. Press .

4. Set the route to your destination.

 **Calculating the Route** P. 108

ZAGAT Review

The ZAGAT® survey for some restaurants is included in the database and displayed when entering a restaurant as a destination. You can view an explanation of the data displayed for the surveyed restaurants.



1. Rotate to select a restaurant with the **Z** icon from the place list. Press .
 2. Rotate to select ZAGAT Review. Press .
- ▶ Press (or say "Read List") to have the system read the ZAGAT® review.
 - ▶ Move to select **Help** for details on the ratings and symbols.

ZAGAT Review

Scrolling through the review is disabled while the vehicle is moving.

ZAGAT provides restaurant information only in the U.S.

Download POI

📍 MENU button ▶ **More Search Methods** ▶ **Download POI**

Select a place imported into the navigation system as the destination.

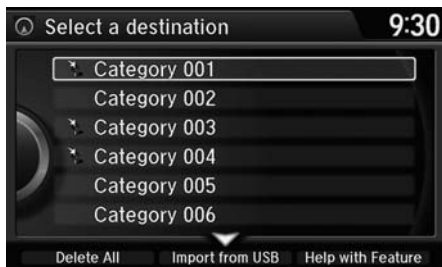

1. Rotate 🔄 to select a category from the list. Press 📍.



2. Rotate 🔄 to select a place. Press 📍.

3. Set the route to your destination.
 ➤ **Calculating the Route** P. 108

Download POI

Move 📍 and rotate 🔄 to select the following items:



- **Import from USB:** Imports POI data into the navigation system.
 ➤ **Importing POI Categories** P. 46
- **Delete All:** Deletes all POI entries.
- **Help with Feature:** Views tips for the Download POI feature.

Scenic Route

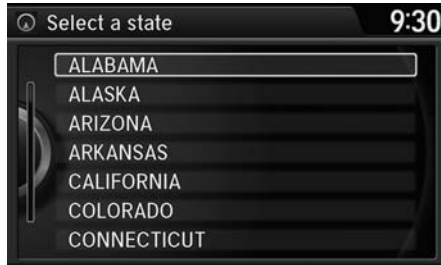

MENU button ▶ **More Search Methods** ▶ **Scenic Route**

Select a scenic road as a destination (U.S. and Canada only).



1. Rotate  to select a state. Press .



2. Rotate  to select a scenic road. Press .

3. Set the route to your destination.

➤ **Calculating the Route** P. 108

Scenic Route

If you select a scenic road that runs through multiple states, only the portion of the road in the selected state is displayed.

Intersection

📍 MENU button ▶ **More Search Methods** ▶ **Intersection**

Select the intersection of two streets as the destination. The state or province for your current location is displayed at the top of the screen (e.g., California).



1. Rotate 🔄 to select the intersection search method. Press 📍.

2. Set the route to your destination.

➤ **Calculating the Route** P. 108

The following options are available:

- **City:** Selects the city where the intersection is located. You are prompted to enter the name of the two intersecting streets.
➤ **Selecting a City** P. 88
- **Street:** Selects the two intersecting streets. The city or cities that the streets are located in are displayed.
➤ **Selecting a Street** P. 89
- **Change State:** Selects the state or province.
➤ **Selecting the State or Province** P. 87

Intersection

It is usually easier to select **Street** to find the streets first. The city or cities that the streets are in will be displayed. If you select **City** and your city is not listed, it may be part of a larger metropolitan area. Try entering the street first.

If the intersection is outside the state you are currently in, rotate 🔄 to select **Change State**.
➤ **Selecting the State or Province** P. 87

If there is more than one intersection, you are prompted to select the intersection. If the two streets that you have selected do not intersect, no intersection is entered.



Map Input

 MENU button ▶ **More Search Methods** ▶ **Map Input**



Use the Interface Dial to manually select an icon or a location on the map screen as the destination.

You are prompted to define the map area to display.





1. Rotate  to select an item. Press .

The following items are available:

- **Current Position:** Your current location is centered on the map.
- **State:** You are prompted to select the state.
 **Selecting the State or Province** P. 87
- **City:** You are prompted to select the city.
 **Selecting a City** P. 88
- **USA, Canada and Mexico:** Your current location is displayed on a map of the country.



2. Scroll the map to position the cursor over your desired destination, adjusting the map scale as necessary.
 - ▶ If the address is not the desired location, scroll the map to another location and try again.
3. Press  to display the route calculation menu.
 - ▶ **Calculating the Route** P. 108
4. Rotate  to select **Set as Destination**. Press .

Map Input

Auto Zoom

Press  repeatedly on the map to zoom in (to the scale 1/4 mile) while scrolling the map.

Information icons are displayed at scales from 1 mile to 1/4 mile. Place/landmark icons are displayed at 1/8 mile or less. Roads are displayed at 1/4 mile or less.

If you select multiple icons within the cursor radius, you are prompted to select one of the items from a list.

▶ **Selecting a Destination on the Map** P. 132

Coordinate

MENU button ▶ **More Search Methods** ▶ **Coordinate**

Specify a location using latitude and longitude map coordinates.

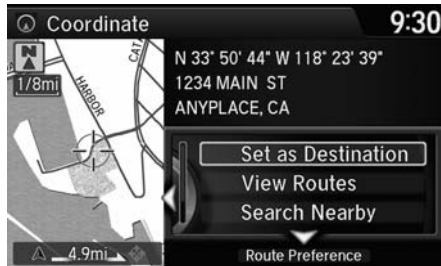

1. Enter the latitude and select **OK**.
2. Enter the longitude and select **OK**.

3. Move to scroll the map to position the cursor over your desired destination, adjusting the map scale as necessary.

▶ If the address is not the desired location, scroll to another location and try again.

4. Press to display the route calculation menu.
 - ▶ **Calculating the Route** P. 108

5. Rotate to select **Set as Destination**. Press .

Coordinate

Latitude and longitude must be entered up to the seconds' value.

Calculating the Route

This section describes how to calculate your route.



1. Rotate to select **Set as Destination**. Press .

▶ The system calculates and displays the route line on the map screen.

➤ **Route Line** P. 112

▶ Move to scroll the map around the destination.

The following options are available:

• **View Routes:** Displays three different routes.

➤ **Viewing the Routes** P. 109

• **Route Preference:** Move to select **Route Preference** to change the route preferences (calculating method).

➤ **Route Preference** P. 50

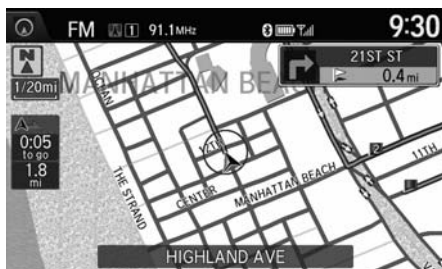

2. Follow the route guidance to your destination.

➤ **Driving to Your Destination** P. 110

▶ The system provides you with pop-up messages if your route passes through unverified areas, avoid areas, or areas with traffic restrictions.

Calculating the Route

The straight line distance (as the crow flies, not driving distance) and direction to the destination are shown.

You cannot use voice commands while the system is calculating the route.

Search Nearby

You can find the nearest place/landmark (e.g., nearest gas station) by specifying a category.

➤ **Find Nearest Place** P. 131

Call

You can place a telephone call to the destination phone number.

➤ **Bluetooth® HandsFreeLink®** P. 204

Save to Address Book

You can add the destination address to the address book.

➤ **Adding an Address Book Entry** P. 37

Edit/Delete Entry

You can edit or delete the address book entry.

➤ **Editing an Address Book Entry** P. 39

Edit Home Entry

You can edit your home address entry.

➤ **Home Address** P. 42

ZAGAT Review

You can view the ZAGAT® rating information.

➤ **ZAGAT Review** P. 101

Viewing the Routes

View three different routes to your destination.



Rotate  to select a route. Press .

- ▶ The travel distance and estimated travel time is displayed for each route.
 - ▶ The system calculates and displays the route line on the map screen.
- **Route Line** P. 112

Viewing the Routes

It is not unusual for some calculated route options to be identical.

This section describes how to follow the route guidance to your destination, receive traffic information and choose the icons displayed on the map screen.

Viewing the Route

Map Screen



After calculating the route to your destination, the route is displayed on the map screen.

➤ **Map Screen Legend** P. 9

As you drive, the system tracks your position on the map in real time and provides guidance as you approach each guidance point on the route.

➤ **During Route Guidance** P. 10

Viewing the Route

🗨️ *“Display Map”*

You can change the map scale using voice commands (e.g., say 🗨️ *“Display 2 mile scale”*).

➤ **Map Scale Commands** P. 308

You can also change the map scale by rotating 🔄.

You can control the icons displayed on the map screen using voice commands (e.g., say 🗨️ *“Display post office”*).

➤ **Map Display Commands** P. 308

You can obtain information about the route using voice commands (e.g., say 🗨️ *“How long to the destination?”*).

➤ **Route Commands** P. 310

You can display the next guidance point on the map screen by saying 🗨️ *“Display Map Guide”* (when en route).

If you scroll the map while en route, the time and distance to destination indicators are replaced with an indicator showing distance from the current vehicle position.

You can display only the map screen or a split map-guidance screen.

➤ **Guidance Mode** P. 58

■ Guidance Screen

The guidance screen offers an alternative way to view your route.



- ▶ The next guidance point is displayed as you approach each guidance point on the route.
- ▶ You can also view a list of guidance directions.

☒ Guidance Screen

A visual guide helps you check the guidance screen.

☒ **Guidance Screen** P. 10

Route Line

When driving on verified streets, the route line is light blue. The route line display changes when driving on unverified streets:

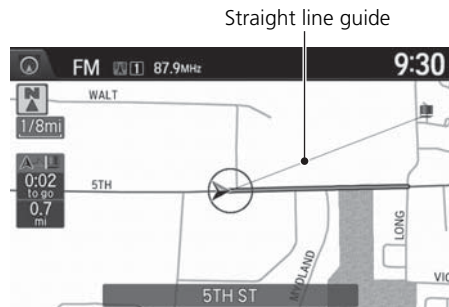

- If **Unverified Routing** is **Off**, the route line uses verified streets only (when possible). If **Straight Line Guide** is set to **On**, a pink “vector line” pointing directly towards your destination is displayed.
 - **Straight Line Guide** P. 73

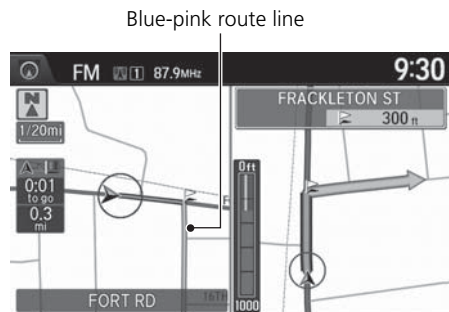

- If **Unverified Routing** is **On**, the route line changes to a blue-pink line to indicate that the route line uses unverified streets.

Route Line

You can set **Unverified Routing** to **Off** to follow your own route to the destination. If **Unverified Routing** is **On**, be aware that unverified streets may not be displayed accurately.

➤ **Unverified Routing** P. 51

You can always view the entire route by simply saying  “Display entire route.”

The route line may also consist of red, orange, or green segments when traffic information is displayed.

➤ **Map Screen Legend** P. 9

➤ **Traffic Rerouting™** P. 120

■ Deviating From the Planned Route

If you leave the calculated route, the system automatically recalculates a route to the desired destination based on your current location and direction.

➤ **Route Preference** P. 50

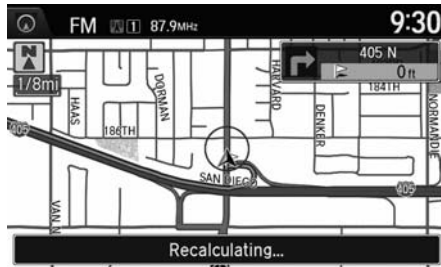

■ Tracking Dots

You can display a series of dots (breadcrumbs) to track the path you are taking. If needed, you can follow the dots back to the mapped road you originally left.

➤ **Display Tracking** P. 79

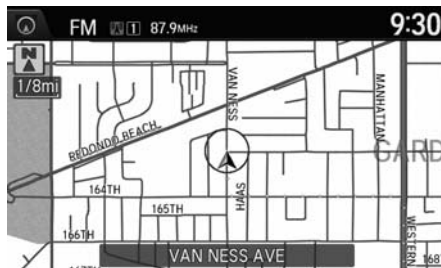

➤ Tracking Dots

A message “Not on a digitized road” may appear when you drive half a mile away from a mapped road.

Breadcrumbs may occasionally be displayed in urban areas, such as large parking lots in shopping malls, in new subdivisions where the roads are not yet in the database, or in areas where a GPS signal is unavailable, such as in a parking garage.

Breadcrumbs are limited to approximately 150 miles. Breadcrumbs at the beginning of the trail are deleted if you exceed that distance.

Breadcrumbs are displayed only at 1/20, 1/8, 1/4, and 1/2 mile map scales.

Listening to Voice Guidance

 ENTER button (on map) ▶ **Voice**

As you approach each guidance point, a pop-up window is displayed on the map screen with instructions for you to follow. Voice guidance for each guidance point is also provided.

Typically, you hear three prompts:

- 1/2 mile from the guidance point (2 miles on freeway)
- 1/4 mile from the guidance point (1 mile on freeway)
- Just before the guidance point

To replay voice guidance, rotate  to select **Voice** in the Map Menu.

If you select **Voice** between guidance points, voice guidance for the next guidance point is provided.

Listening to Voice Guidance

 "Voice" (on the map screen)

You can turn voice guidance OFF if you prefer. Press the **SETTINGS** button. Select **System Settings** and set **Volume** to **0**.

When driving in unverified areas, the phrase "if possible" is inserted before each voice guidance prompt.

Voice in the Map Menu may be grayed out if:



- The system is in process of gathering the route guidance information.
- The vehicle is out of the road (e.g., pulling in a parking lot).

The timing of voice guidance varies depending on the type of road you are on and the distance to the next guidance point.

Reaching a Waypoint

When you reach a waypoint, a pop-up message is displayed. You can continue or pause the route guidance.



Rotate  to select **No** to pause the route guidance. Press .

▶ Select **Yes** to continue the guidance.

Resuming the route guidance

You can resume the route guidance in the following ways:

- Restart the engine when you stop your car (e.g., to rest, stop for gas, etc.).
 ▶ **Resuming Your Trip** P. 134
- Select **Resume Guidance** from the navigation menu or the map menu.
 ▶ **Map Menu** P. 116
 ▶ **Changing Your Route** P. 122

Displaying the Map Menu

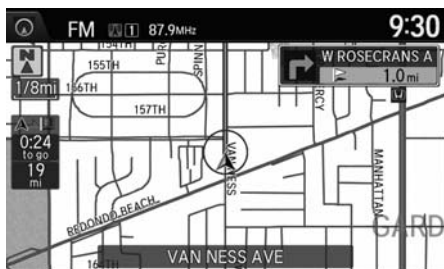

Use the Map Menu to control the icons displayed on the screen and to display traffic information and messages. You can also use the Map Menu to find locations or to cancel the route.



1. On the map screen, press .

▶ The Map Menu is displayed on the map screen.



2. Rotate  to select an item. Press .

The following items are available:

- **Voice:** Select to hear the voice guidance when en route.
▶ **Listening to Voice Guidance** P. 114

Map Menu

If you scroll the map while en route, press the NAV (or BACK) button to return to the current position map screen, then press .

Traffic Incidents

You must be in or near a traffic-enabled city to receive coverage for that area. FM Traffic is available in the lower 48 states and Hawaii.

The incident icons are displayed on the 5 mile or less map scale.

▶ **Map Scale and Functions** P. 76

- **Map/Guidance:** Allows you to select the map and guidance settings (display mode, icons to display on the map, map orientation, map color, and 3D view angle), display your current location and an overview of the map features.
 - **Guidance Mode** P. 58
 - **Showing Icons on Map** P. 67
 - **Color** P. 69
 - **View (Map Orientation)** P. 72
 - **3D Angle Adjustment** P. 73
 - **Current Location** P. 74
 - **Map Legend** P. 75
- **Pause Guidance:** Pauses your current route.
 - **Pausing the Route** P. 123
- **Resume Guidance:** Resumes your current route. This item is displayed while the route guidance is paused.
- **Cancel Route:** Cancels your current route.
 - **Canceling the Route** P. 123
- **Directions:** Displays a list of the guidance points.
 - **Directions** P. 118
- **Search Nearby:** Allows you to find the nearest place/landmark (e.g., nearest gas station) by specifying a category. You can then add the location to the list of destinations, set as a waypoint, or set as your destination.
 - **Find Nearest Place** P. 131
- **Traffic Incidents:** Displays a list of the traffic incidents around your current location or on your current route.
 - **Traffic Rerouting™** P. 120

➤ Map Menu

Directions

The system provides freeway exit information only in the U.S.

Directions

📍 ENTER button (on map) ▶ **Directions**

Display a list of the guidance points on your route for your confirmation.



1. Rotate 🔄 to select a guidance point from the list. Press 📍.
▶ The system displays a map of the guidance point.

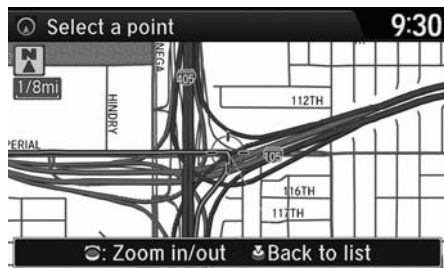

2. Press 📍 to select **Back to list** or press the BACK button to return to the previous screen.

Directions

Guidance points with exit information are indicated by a **i** (freeway exit information) icon. Move 📍 to select **Exit Info** to display the exit information.

▶ **Freeway Exit Information** P. 119

The system provides freeway exit information only in the U.S.



The route guidance information is automatically deleted when you reach your destination.



Freeway Exit Information



ENTER button (on map) ▶ **Directions** ▶ **Exit Info**

Display a list of the freeway exits for the route. You can view freeway exit information (whether the exit is near gas stations, restaurants, ATMs, etc.) and add new destinations or waypoints to the calculated route.



1. Rotate  to select an exit from the list. Press .

2. Rotate  to select a list item. Press .



▶ Move  or  to display information for different exits.

▶ You can set the route to your destination.

▶ **Calculating the Route** P. 108

Freeway Exit Information

 "Display Freeway Exit Information"

You can scroll the map and select a  (freeway exit information) icon on the map screen to display the freeway exit information. The  icon is only displayed if there is exit information available.

Icons are displayed only at 1/4, 1/2, or 1 mile scale.

▶ **Showing Icons on Map** P. 67

The system provides freeway exit information only in the U.S.

The route guidance information is automatically deleted when you reach your destination.

Traffic Rerouting™

When driving to your destination, the system automatically searches for a faster route based on traffic flow information and traffic incidents.

➤ **Map Screen Legend** P. 9

➤ **Traffic Rerouting** P. 53



Traffic Rerouting™ Manually

🗨 ENTER button (on map) ▶ **Traffic Incidents**

Manually avoid specific incidents and/or congestion on your route:



1. Rotate 🌀 to select an incident from the list. Press 🗨.

▶ The system displays the map screen and the incident location.

⌘ Traffic Rerouting™

Automatic traffic rerouting may not provide a detour route depending on circumstances.



⌘ Traffic Rerouting™ Manually



🗨 "Display traffic incidents", 🗨 "Display traffic list"

You can display traffic incidents and related information on the map screen using voice commands.

➤ **Map Display Commands** P. 308



2. Rotate  to select **Avoid**. Press .
 - ▶ Repeat step 1 to 2 as necessary.

3. Move  to select **Reroute**. Press .
 - ▶ The system recalculates a detour route that avoids the traffic incidents.

▶ Traffic Rerouting™ Manually

You can choose to avoid up to 10 traffic incidents. It is not always possible for the system to calculate a route that avoids all traffic incidents or specific traffic incidents you select.

The “On Route” tab on the Traffic List screen is only available during route guidance.

You cannot select an incident to avoid from the “All” tab.

You can also detour around a traffic incident manually if you encounter an unexpected obstacle.

▶ **Taking a Detour** P. 130





 MENU button (when en route)

This section describes how to alter your route, add an interim “waypoint” (pit stop), choose a different destination, cancel your current destination, and continue your trip after stopping.





Rotate  to select an item. Press .

The following items are available:

- **Voice:** Select to hear the voice guidance when en route.
 **Listening to Voice Guidance** P. 114
- **Destination List:** Shows a list of waypoints. You can delete waypoints or edit the order of them.
 **Editing the Destination List** P. 128
- **Pause Guidance:** Pauses your current route.
 **Pausing the Route** P. 123
- **Resume Guidance:** Resumes your current route. This item is displayed while the route guidance is paused.
- **Cancel Route:** Cancels the route guidance.
 **Canceling the Route** P. 123
- **View Routes:** Displays three different routes.
 **Viewing the Routes** P. 109

Changing Your Route

 “Display Destination”,  “Display Navigation” (when en route)

If you press the MENU button when not en route, the Destination Menu screen is displayed.

 **Entering a Destination** P. 84

- **Change Route Preference:** Changes the route preferences (calculating method).
 ▶ **Route Preference** P. 50
- **Detour:** Calculates a detour route.
 ▶ **Taking a Detour** P. 130
- **Avoid Streets:** Avoids streets along your route.
 ▶ **Avoiding Streets** P. 130

Pausing the Route

🗨 MENU button (when en route) ▶ **Pause Guidance**

Pause the route guidance and return to the map screen. The destination icons and all waypoint flags remain displayed on the map. Press the MENU button when en route and select **Resume Guidance** to resume the route guidance.

Canceling the Route

🗨 MENU button (when en route) ▶ **Cancel Route**

Cancel the route guidance and remove the destination and all waypoints from the destination list. The system then returns to the map screen.

▶▶ Pausing the Route

You can also pause your route from the Map Menu.

▶ **Map Menu** P. 116

▶▶ Canceling the Route

You can also cancel your route from the Map Menu.

▶ **Map Menu** P. 116

Adding Waypoints

Add up to four waypoints (pit stops) along the route to your destination.



Waypoints are displayed on the map screen as small, numbered red flags. The route follows the waypoints in the order they are listed in the Destination List.

✕ Adding Waypoints

Waypoints allow you to stop for gas or food, for example, and then continue on to your destination.

Press the NAV button to return to the map screen without adding a waypoint at any time.

The search corridor used for adding waypoints can be adjusted.

✕ **Edit POI Search Radius Along Route** P. 54

You can delete waypoints or edit the order of waypoints in the destination list.

✕ **Editing the Destination List** P. 128

■ Adding Waypoints from the Route Menu

📍 MENU button (when en route) ▶ **Destination List** ▶ **Add New Destination** ▶ **Find Along Route**



1. Rotate 🔄 to select a search method to add a waypoint. Press 📍.

The following items are available:

- **Search Around:** Searches in a spiral pattern around the location you select.
- **Search Along:** Searches within a “corridor” on either side of the locations you select.

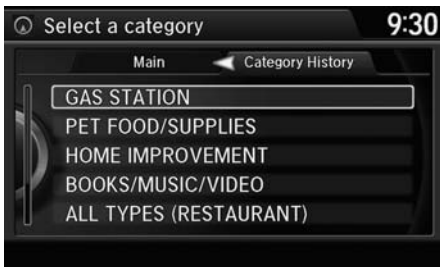



2. Rotate 🔄 to select a waypoint category (e.g., **GAS STATION**). Press 📍.

▶▶ Adding Waypoints

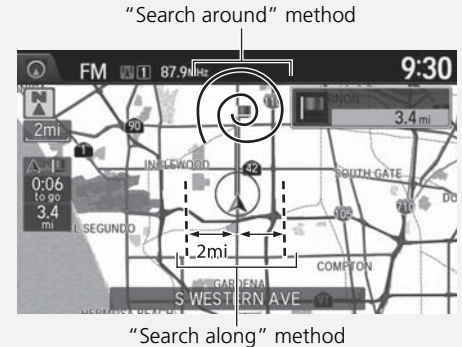
Search method

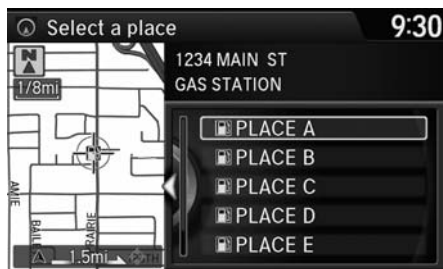







3. Rotate  to select a place. Press .

► The waypoint is added to the Destination List.



4. Rotate  to select a location and move the order of destinations. Press .



5. Move  and rotate  to select **Start Route**. Press .

► The route is automatically recalculated and displayed on the map screen.

■ Adding Waypoints from the Navigation Menu



📍 MENU button (when en route) ▶ **Destination List** ▶ **Add New Destination** ▶ **Use Nav Menu**



1. Rotate  to select a method to enter a waypoint.

▶ **Entering a Destination** P. 84

▶ A new destination is added to the end of the Destination list.

2. Move  and rotate  to select **Start Route**. Press .

▶ The route is automatically recalculated and displayed on the map screen.

▣ Adding Waypoints from the Navigation Menu

You can edit the order of waypoints and destination.



▶ **Editing the Destination List** P. 128

Editing the Destination List

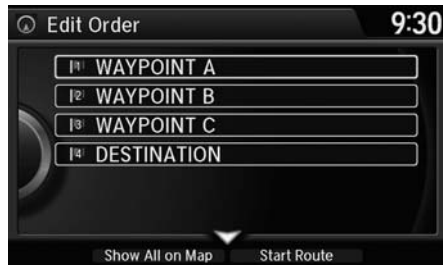

Editing the Order of Waypoints



 MENU button (when en route) ► **Destination List**



1. Move  and rotate  to select **Edit Order**. Press .



2. Rotate  to select a list item to move. Press .

3. Rotate  to select a new location. Press .

4. Move  and rotate  to select **Start Route**. Press .

► The route is automatically recalculated and displayed on the map screen.

Editing the Order of Waypoints

Move  to rotate  to select **Show All on Map** to display the destination and waypoints on the map screen.

Deleting Waypoints

MENU button (when en route) ► **Destination List**



1. Rotate to select a list item to delete. Press .

Deleting Waypoints

Move and rotate to select **Delete All** to delete the destination and all the waypoints.

Select **Show on Map** to display the waypoint on the map screen.



2. Rotate to select **Delete**. Press .

3. Rotate to select **Yes**. Press .

Taking a Detour

📍 MENU button (when en route) ► **Detour**

Calculate a detour route manually. The system attempts to calculate a new route by avoiding the next 5 miles (while on a freeway) or 1 mile (while on a surface street).

Avoiding Streets

📍 MENU button (when en route) ► **Avoid Streets**

Select a street or streets along your route to avoid.



1. Rotate 📍 to select the street you want to avoid. Press 📍.

► Repeat the procedure to avoid other streets.



2. Move 📍 to select **Recalculate Route**. Press 📍.

► The system calculates a new route.

✕ Taking a Detour

The detour option is convenient if you encounter an unexpected obstacle such as a road closure or extremely heavy traffic congestion.

✕ Avoiding Streets

Avoiding certain streets is convenient if you know of road construction, road closures, or excessive traffic along the route.

You cannot choose specific streets you want to use, only those to avoid. However, you can select intersections or waypoints (places/landmarks) that the system will use in your route.

✕ Adding Waypoints P. 124

You can store up to 10 streets to avoid. You cannot avoid your current street or the streets of your waypoint(s) or destination (system beeps if selected).













There are several methods you can use to change the route destination.

Find Nearest Place

 ENTER button (on map) ► **Search Nearby**

Search for the nearest place/landmark on the map screen and set it as your destination.



1. Rotate  to select **Search Nearby**. Press .
2. Rotate  to select a category type. Press .
3. Rotate  to select a place. Press .
4. Rotate  to select **Set as Destination**. Press .
5. Move  to select **Clear Current Route**. Press .
 - The route is automatically recalculated and displayed on the map screen.
 - Rotate  to edit the order to set the location as a new waypoint. Press .

Find Nearest Place

 "Find Nearest..."

The Find Nearest voice command is the fastest method of specifying a place/landmark as your destination. Many kinds of places can be found.

► **Find Place Commands** P. 309

Selecting a Destination on the Map

Select a new destination when en route by selecting a location on the map.

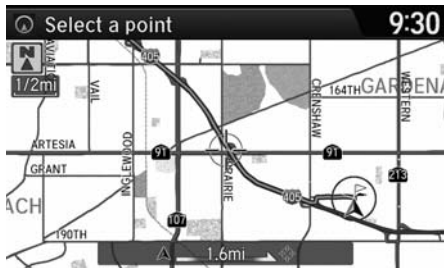

1. Scroll the map to position the cursor over your desired destination, adjusting the map scale as necessary. Press

► If the address displayed is not the desired location, press the BACK button and repeat the procedure.

2. Rotate to select **Set as Destination**. Press .

► **Calculating the Route** P. 108



3. Move to select **Clear Current Route**. Press .

► The route is automatically recalculated and displayed on the map screen.

► Rotate to edit the order to set the location as a new waypoint. Press .



► Selecting a Destination on the Map

If there is more than one icon or street under the map cursor, you are prompted to select the item from a list.

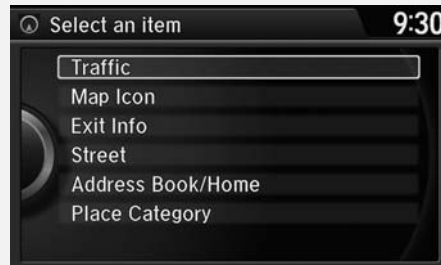

Rotate to select an item. Press .

Entering a New Destination

 MENU button (when en route) ▶ **Destination**



Enter a new destination using the Destination Menu screen even when you are en route.





1. Rotate  to select a method to enter a new destination.

 **Entering a Destination** P. 84

▶ After entering a new destination, the address is displayed on the Calculate Route screen.



2. Rotate  to select **Set as Destination**. Press .

3. Move  to select **Clear Current Route**. Press .

▶ The route is automatically recalculated and displayed on the map screen.

▶ Rotate  to edit the order to set the location as a new waypoint. Press .



▶▶ Entering a New Destination

 "Display Destination",  "Display Navigation"

Stop your vehicle en route (e.g., to rest, stop for gas, etc.), and then continue on your route.

If you did not complete your route, the Continue Trip screen is displayed when you restart your vehicle.



Rotate  to select **Set as Destination**. Press .

- ▶ You can continue on the same route.
- ▶ Move  to scroll the map around the destination.
- ▶ Press the BACK button to cancel your destination.

- **Route Preference:** Move  to select **Route Preference** to change the route preferences (calculating method).
▶ **Route Preference** P. 50
- **View Routes:** Displays three different routes.
▶ **Viewing the Routes** P. 109

Resuming Your Trip

The Continue Trip screen has the same options as when you calculate a route.

▶ **Calculating the Route** P. 108

You can also cancel your destination by pressing any hard button except the  button

Search Nearby

You can find the nearest place/landmark (e.g., nearest gas station) by specifying a category.

▶ **Find Nearest Place** P. 131

Call

You can place a telephone call to the destination phone number.

▶ **Bluetooth® HandsFreeLink®** P. 204

Save to Address Book

You can add the destination address to the address book.

▶ **Adding an Address Book Entry** P. 37

Edit/Delete Entry

You can edit or delete the address book entry.

▶ **Editing an Address Book Entry** P. 39

Edit Home Entry

You can edit your home address entry.

▶ **Home Address** P. 42

ZAGAT Review

You can view the ZAGAT® rating information.

▶ **ZAGAT Review** P. 101

Audio

This section describes how to operate the audio system. You can play music from a wide array of media sources, and control the audio system using the audio buttons, the Interface Dial, or voice control.



Audio System	136	XM® Radio Service	157	Pandora® Menu	190
About Your Audio System	136	Playing a Disc	158	Aha™ Radio Menu	191
USB Port	137	Selecting Disc Mode	158	Playing a USB Flash Drive	193
Auxiliary Input Jack	138	Audio Screen Control	159	Selecting USB Mode	194
Audio System Theft Protection	139	Audio Menu	160	Audio Screen Control	195
Setting Audio Shortcuts	140	Recommended CDs	163	Audio Menu	196
Audio Remote Controls	142	Playing Hard Disc Drive (HDD) Audio	165	Playing Bluetooth® Audio	199
Steering Wheel Controls	142	Selecting HDD Mode	165	Selecting <i>Bluetooth</i> ® Audio Mode	199
Audio Settings	143	Recording a Music CD to HDD	166	Audio Screen Control	200
Adjusting the Sound	145	Audio Screen Control	167		
Playing FM/AM Radio	147	Audio Menu	168		
Selecting FM/AM Mode	147	Playing an iPod®	177		
Audio Screen Control	147	Selecting iPod® Mode	178		
Audio Menu	149	Audio Screen Control	179		
Playing XM® Radio	153	Audio Menu	181		
Selecting XM® Mode	153	Song By Voice™ (SBV)	184		
Audio Screen Control	153	Playing Internet Radio	189		
Audio Menu	155	Selecting Internet Radio Mode	189		

About Your Audio System

The audio system features AM/FM radio and the XM® Radio service. It can also play audio CDs, WMA/MP3/AAC files, Hard Disc Drive (HDD) audio, USB flash drives, and iPod®, iPhone® and *Bluetooth*® devices.

You can operate the audio system from the buttons and switches on the panel, the icons on the touchscreen interface.

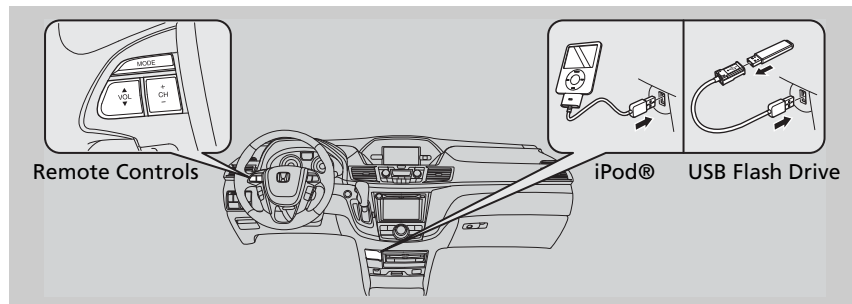

▣ About Your Audio System

XM® Radio is available on a subscription basis only. For more information on XM® Radio, contact a dealer.

▣ **XM® Radio Service** P. 157

XM® Radio is available in the United States and Canada, except Hawaii, Alaska, and Puerto Rico.

XM® is a registered trademark of Sirius XM Radio, Inc.

Video CDs, DVDs, and 3-inch (8-cm) mini CDs are not supported.

iPod® and iPhone® are registered trademarks owned by Apple Inc.

State or local laws may prohibit the operation of handheld electronic devices while operating a vehicle.

When the screen is viewed through polarized sunglasses, a rainbow pattern may appear on the screen due to optical characteristics of the screen. If this is disturbing, please operate the screen without polarized sunglasses.

USB Port

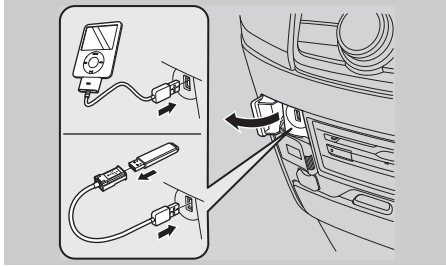

Install the iPod® or iPhone® dock connector or the USB flash drive to the USB port.

⌘ USB Port

- Do not leave the iPod® or USB flash drive in the vehicle. Direct sunlight and high temperatures may damage it.
- Do not connect the iPod® or USB flash drive using a hub.
- Do not use a device such as a card reader or hard disk drive, as the device or your files may be damaged.
- We recommend backing up your data before using the device in your vehicle.
- Displayed messages may vary depending on the device model and software version.

If the audio system does not recognize the iPod®, try reconnecting it a few times or reboot the device. To reboot, follow the manufacturer's instructions provided with the iPod® or visit www.apple.com/ipod.

Auxiliary Input Jack

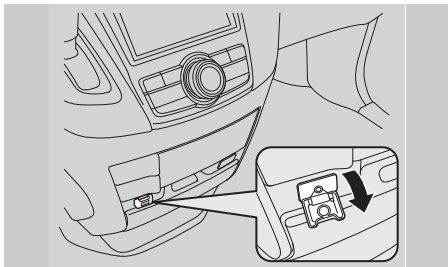

Use the jack to connect standard audio devices.

1. Open the AUX cover.
2. Connect a standard audio device to the input jack using a 1/8 inch (3.5 mm) stereo miniplug.
 - ▶ The audio system automatically switches to the AUX mode.

✕ Auxiliary Input Jack

You can return to the AUX mode by selecting **Change Source** on the Audio menu screen or **Audio Source** on the touchscreen.

Audio System Theft Protection

The audio system is disabled when it is disconnected from the power source, such as when the battery is disconnected or goes dead. In certain conditions, the system may display **Enter code**. If this occurs, reactivate the audio system.

■ Reactivate the audio system

1. Set the power mode to ON.
2. Turn on the audio system.
3. Press and hold the audio system power button for more than two seconds.
 - ▶ The audio system is reactivated when the audio control unit establishes a connection with the vehicle control unit. If the control unit fails to recognize the audio unit, you must go to a dealer and have the audio unit checked.

Setting Audio Shortcuts

You can store up to six radio stations, and HDD audio album/play lists when playing AM, FM, or XM® radio, or HDD audio.

Storing a station or song



1. Select Shortcuts.
2. Tune to a radio station or select a song.

▶ **Playing FM/AM Radio** P. 147

▶ **Playing XM® Radio** P. 153

▶ **Playing Hard Disc Drive (HDD) Audio** P. 165

3. Select Edit or No Entry.

▶ If you select No Entry, go to step 5.

4. Select Add.

5. Select the preset icon you want to store the station or song to.

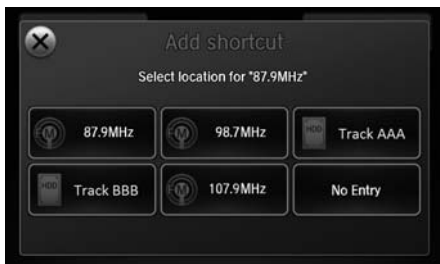

Setting Audio Shortcuts

You can also preset a station or song by pressing and holding the preset icon you want to store that station or song after step 3.

■ Deleting a preset station or song

1. Select **Shortcuts**.
2. Select **Edit**.
3. Select **Delete**.
4. Select the preset icon with the radio station or a song you want to delete.

Steering Wheel Controls

Allows you to operate the audio system while driving.

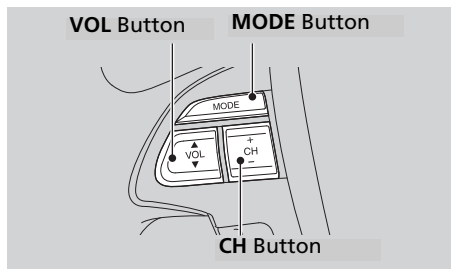

MODE Button

Cycles through the audio modes as follows:

FM→AM→XM→CD→HDD→USB→

iPod®→Bluetooth® Audio→

Pandora®→Aha™→AUX

VOL Button

Press ▲: To increase the volume.

Press ▼: To decrease the volume.

CH Button

- When listening to the radio
 - Press +: To select the next preset radio station.
 - Press -: To select the previous preset radio station.
 - Press and hold +: To scan to the next strong station.
 - Press and hold -: To scan to the previous strong station.
- When listening to a CD, HDD, iPod®, USB flash drive, or Bluetooth® Audio
 - Press +: To skip to the next song.
 - Press -: To go back to the beginning of the current or previous song.
 - Press and hold +: To go to the group up. (Bluetooth® Audio only)
 - Press and hold -: To go to the group down. (Bluetooth® Audio only)
- When listening to a CD, HDD or USB flash drive
 - Press and hold +: To skip to the next folder.
 - Press and hold -: To go back to the previous folder.
- When listening to Pandora® or Aha™
 - Press +: To skip to the next song.
 - Press and hold +: To select the next station.
 - Press and hold -: To select the previous station.

Audio Remote Controls

The CD mode appears only when a CD is loaded.

The USB mode, iPod® mode, Bluetooth® Audio mode, Pandora® mode, and Aha™ mode appear when a connection (Bluetooth or USB) is established with a device.

SETTINGS button ► **Audio Settings**



Rotate  to select an item. Press .

The following items are available:

- **Sound:** Adjusts the settings of the audio speaker's sound.
 ▶ **Adjusting the Sound** P. 145
- **Source Select Popup:** Selects whether the list of selectable audio sources comes on when the AUDIO button is pressed.
- **HD Radio Mode (AM/FM mode):** Selects whether the audio system automatically switches to the digital radio waves or receives the analogue waves only.
- **Cover Art (CD (MP3/WMA/AAC), iPod®, USB, Pandora® or Aha™ mode):** Turns on and off the cover art display.
- **Connect Bluetooth Audio Device (Bluetooth® Audio, Pandora® or Aha™ mode):** Connects, disconnects or pairs a *Bluetooth®* Audio device to HFL.
- **Recording from CD (CD mode):** Selects whether the songs on music CDs are automatically recorded to the HDD.
- **Recording Quality (CD mode):** Selects the quality of the music files recorded to the HDD.
- **HDD Info (HDD mode):** Displays the HDD capacity.





- **Update Gracenote Album Info** (CD or HDD mode): Updates the Gracenote® Album Info (Gracenote® Media Database) from CD or from USB.
▶ **Updating Gracenote® Album Info** P. 175
- **DVD Auto Play** (DVD mode): Turns the auto play feature on or off.
- **Audio Language** (DVD mode): Selects a language for the audio that is available on the DVD.
- **Subtitle Language** (DVD mode): Selects a language for the subtitle that is available on the DVD.
- **Menu Language** (DVD mode): Selects a language for the DVD menu that is available on the DVD.
- **Angle Mark** (DVD mode): Sets whether to display the angle symbol.
- **Dynamic Range** (DVD mode): Sets whether to control the range of the loud and low sounds.
- **Delete all HDD Data** (HDD mode): Resets all the menu and customized settings, and delete all music data on the HDD.
- **Default**: Cancels/Resets all customized items in the Audio Settings group as default.

Adjusting the Sound

Interface Dial

SETTINGS button ▶ **Audio Settings** ▶ **Sound**



1. Rotate  to select the sound mode to adjust. Press .
2. Rotate  to adjust the desired level. Press .

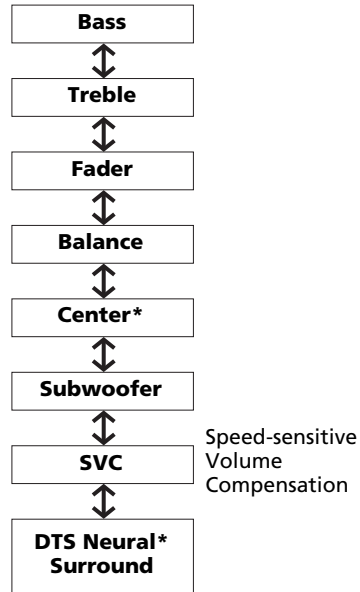

▶▶ Adjusting the Sound

The SVC has four modes: **Off**, **Low**, **Mid**, and **High**.

SVC adjusts the volume level based on the vehicle speed. As you go faster, audio volume increases. As you slow down, audio volume decreases.

DTS Neural Surround is a trademark of DTS, Inc.

When available, DTS Neural Surround converts stereo sound into surround sound.

*: Not available on all models

Continued

Touchscreen

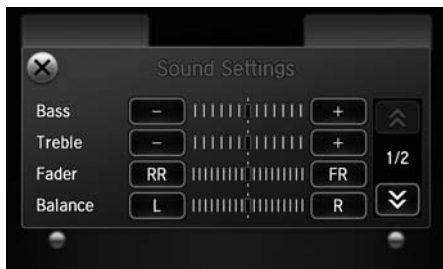

1. Select **More**.
2. Select **Sound Settings**.
3. Use **+**, **-** or other icon to adjust the setting.

Adjusting the Sound

Select **Off**, **Low**, **Mid** or **High** for the SVC setting.





▶ **Adjusting the Sound** P. 145

Select **X** to go back to the previous screen.

Use the **◀▶**/**⬆️**/**⬇️** icons to turn the page.

Selecting FM/AM Mode

Interface Dial

1. Press the MENU button.(in AUDIO mode)
2. Rotate  to select **Change Source**. Press .
3. Rotate  to select the frequency band (FM, AM). Press .
 - ▶ The band and frequency are displayed on the navigation screen.

Touchscreen

1. Select **Audio Source**.
2. Select the frequency band (AM, FM) icon.
 - ▶ The band and frequency are displayed on the touchscreen.

Audio Screen Control

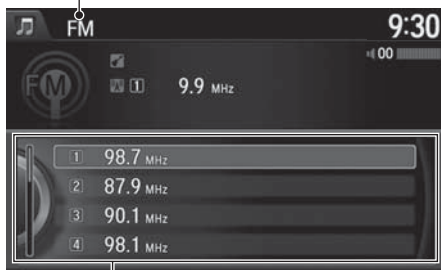

Control the audio system through the navigation screen and touchscreen.

Frequency band



Preset stations

Interface Dial

Rotate  to select a preset station.
Press .

- ▶ Press and hold  for a few seconds to store the current station.
- ▶ Press MENU button to display the menu items.
 - ▶ **Audio Menu** P. 149

▶▶ Playing FM/AM Radio

 "Display audio screen"

You can control the AM/FM radio using voice commands.

▶▶ **Voice Control Operation** P. 5

The **ST** indicator appears on the display indicating stereo FM broadcasts.

Stereo reproduction in AM is not available.

The radio can receive the complete AM and FM bands:

AM band: 530 to 1710 kHz

FM band: 87.7 to 107.9 MHz

You can store 6 AM stations and 12 FM stations into the preset memory.

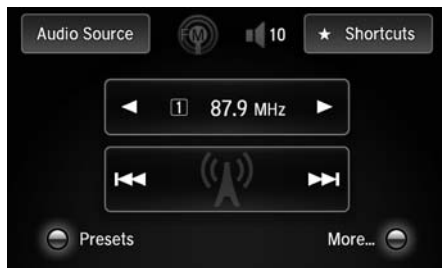

Touchscreen

Select ◀ or ▶ to tune the radio frequency.

Select ◀◀ or ▶▶ to search up and down the selected band for a station with a strong signal.

▶ Select **Presets** to listen a preset station.
Select and hold the preset number you want to store that station.

▶ Select **More** to display the menu item.

➤ **Audio Menu** P. 149

▶ Select **TAG** to tag the song if it is played on an HD Radio™ station*. The iPod®/ iPhone® should be connected to the audio system to store the tagged song information on your device.



*: Not available on all models

Audio Menu

Interface Dial



 MENU button (in FM/AM mode)



Rotate  to select an item. Press .

The following items are available:

- **Scan:** Scans for stations with a strong signal in the current band and plays a 10-second sample. Select **Cancel Scan** to stop scanning and play the current selection.
- **Station List:** Displays the stored station list.
- **Save Preset:** Stores the station into the preset memory.
- **Change Source:** Changes the audio source mode.

- **Radio Text:** Displays the text information broadcast by the current RDS station.
- **Tag Song*:** Displays the TAG information saved to the audio system when an HD Radio™ station is selected.
- **Tagged Song List*:** You can store the TAG information in the connected iPod®/iPhone®. If the iPod®/iPhone® is not connected to the audio system, the information is stored in the audio unit temporarily, then once the device is connected to the system, data is transferred to the iPod®/iPhone®.
- **Tune/Seek:** Tunes the radio to the frequency you select. Rotate  to select a frequency, then Move .
- **HD subchannel*:** Displays the subchannel list when an HD Radio™ station is selected.

▶▶Audio Menu

iTunes Tagging*

“iTunes” in “iTunes Tagging” is a trademark of Apple Inc.

When an HD Radio™ station is selected, the **HD** indicator appears on the navigation screen and touchscreen.

If you want to have the information on the song played from the HD Radio™ station, select **TAG** in touchscreen or select **Tag Song** in the menu with Interface dial.

If iPod®/iPhone® is connected, the tag is transferred to the connected device immediately, otherwise the tag will be transferred when the device will be connected and select **Tag Song** in the menu with Interface dial.

*: Not available on all models

Touchscreen



1. Select **More**.
2. Select a setting item.

The following items are available:

- **Sound Settings**: Displays the sound preferences screen.
 ▶ **Adjusting the Sound** P. 145
- **Scan**: Scans for stations with a strong signal in the current band and plays a 10-second sample. Select **Cancel Scan** to stop scanning and play the current selection.
- **Save Preset**: Stores the station into the preset memory.
- **Screen Settings**: Adjusts the screen's preferences.
 ▶ **Changing the Screen Settings** P. 82
- **HD subchannel***: Displays the subchannel list when an HD Radio™ station is selected.

*: Not available on all models



Radio Data System

 MENU button (in FM mode) ▶ **Station List**

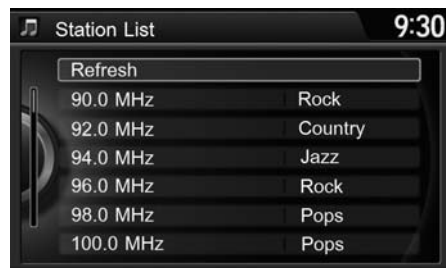
Provides text data information related to your selected RDS-capable FM station.



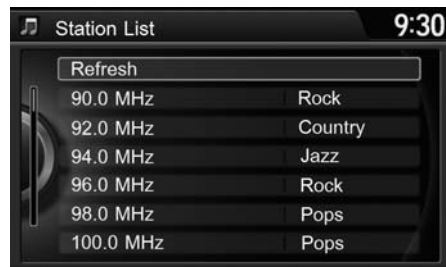

■ To find an RDS station from Station List

Rotate  to select the station. Press .







■ Manual update

Updates your available station list at any time.

Rotate  to select **Refresh**. Press .

Selecting XM® Mode

Interface Dial

1. Press the MENU button. (in AUDIO mode)
 2. Rotate  to select **Change Source**. Press .
 3. Rotate  to select **XM**. Press .
- ▶ The band and channel are displayed on the navigation screen.

Touchscreen



1. Select **Audio Source**.
 2. Select the XM® icon.
- ▶ The band and channel are displayed on the touchscreen.

Audio Screen Control

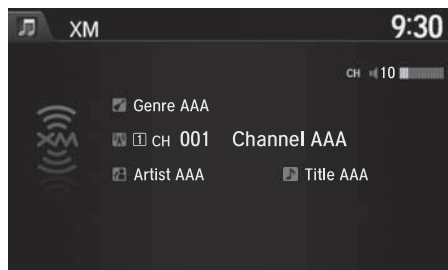
Control the audio system through the navigation screen and touchscreen.



Interface Dial

Rotate  to select a preset channel. Press .

- ▶ Press and hold  for a few seconds to store the current channel.
- ▶ Press MENU button to display the menu items.
- ▶ **Audio Menu** P. 155

▶▶ Playing XM® Radio

You can control the XM radio using voice commands.

▶▶ **Voice Control Operation** P. 5

In the channel mode, all available channels are selectable. In the category mode, you can select a channel within a category (Jazz, Rock, Classical, etc.).

There may be instances when XM® Radio does not broadcast all the data fields (artist name, title). This does not indicate a problem with your audio system.

You can store 12 XM® stations into the preset memory.

XM® Radio stations load in ascending order, which can take about a minute. Once they have loaded, you can scroll up or down to make your selections.

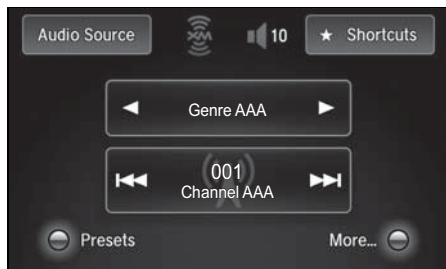

Touchscreen

Select ◀ or ▶ to display and select an XM® Radio category.

Select ◀◀ or ▶▶ to the previous or next channel.

In channel mode, select and hold to change the channel rapidly.

▶ Select **Presets** to listen a preset station.

Select and hold the preset number you want to store that channel on the preset screen.

▶ Select **More** to display the menu item.

▶ **Audio Menu** P. 149

Audio Menu

Interface Dial

 MENU button (in XM mode)



Rotate  to select an item. Press .

The following items are available:

- **Scan:** Scans for channels in the selected mode and plays a 10- second sample. Select **Cancel Scan** to stop scanning and play the current selection.
- **Save Preset:** Stores the station into the preset memory.
- **Change Source:** Changes the audio source mode.
- **Channel List:** Displays the list of available channels. Rotate  to select a channel.
- **XM tune mode:**
 - Channel Mode:** Scans to select all available channels.
 - Category Mode:** Scans to select a channel within a category (Jazz, Rock, Classic, etc.).

Touchscreen

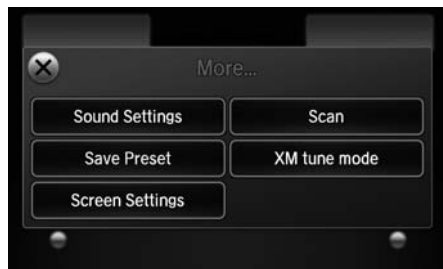

1. Select **More**.
2. Select a setting item.

The following items are available:

- **Sound Settings**: Displays the sound preferences screen.
▶ **Adjusting the Sound** P. 145
- **Save Preset**: Stores the station into the preset memory.
- **Screen Settings**: Adjusts the screen's preferences.
▶ **Changing the Screen Settings** P. 82
- **Scan**: Scans for channels with a strong signal in the selected mode and plays a 10-second sample. Select Cancel Scan to stop scanning and play the current selection.
- **XM tune mode**: Sets the scan mode.
Channel: Scans to select all available channels.
Category: Scans to select a channel within a category (Jazz, Rock, Classic, etc.).

XM® Radio Service

■ Subscribing to XM® Radio

1. You need your radio ID ready before registering for subscription. To see the ID in the display: Select **◀◀** on the touchscreen until channel **0** appears.
2. Have your radio ID and credit card number ready, and either call or visit the XM® website to subscribe.

■ Receiving XM® Radio

Switch to the XM® mode by pressing the SOURCE button repeatedly or operating the touchscreen, and stay in this mode for about 30 minutes until the service is activated. Make sure your vehicle is in an open area with good reception.

■ XM® Radio Display Messages

Loading:

XM® is loading the audio or program information.

Ch off air:

The channel is not currently broadcasting.

Ch unauthorized:

XM® radio is receiving information update from the network.

No signal:

The signal is too weak in the current location.

Ch unavailable:

No such channel exists, the channel is not part of your subscription, or the artist or title information is unavailable.

Check antenna:

There is a problem with the XM® antenna. Contact a dealer.

⌘ Subscribing to XM® Radio

Contact Information for XM® Radio:
XM® Radio at www.siriusxm.com or (800) 852-9696

⌘ Receiving XM® Radio

The XM® satellites are in orbit over the equator; therefore, objects south of the vehicle may cause satellite reception interruptions. Satellite signals are more likely to be blocked by tall buildings and mountains the farther north you travel from the equator.

You may experience reception problems under the following circumstances:

- In a location with an obstruction to the south of your vehicle.
- In tunnels
- On the lower level of a multi-tiered road
- Large items carried on the roof rack

Your audio system supports audio CDs, CD-Rs and CD-RWs in either MP3, WMA, or AAC format. With the CD loaded, select the CD mode.



Selecting Disc Mode



1. Insert a disc into the disc slot.

▶ The disc automatically being playing.

Interface Dial

2. Press the MENU button. (in AUDIO mode)

3. Rotate  to select **Change Source**. Press .

4. Rotate  to select **CD**. Press .

Touchscreen

2. Select **Audio Source**.

3. Select the **CD** icon.

▶ Playing a Disc

NOTICE

Do not use CDs with adhesive labels. The label can cause the CD to jam in the unit.

WMA and ACC files protected by digital rights management (DRM) cannot be played.

The audio system displays Unplayable File, then skips to the next file.

Text data appears on the display under the following circumstances:

- When you select a new folder, file, or track.
- When you change the audio mode to CD.
- When you insert a CD.

If you eject the CD but do not remove it from the slot, the system reloads the CD automatically after several seconds.

You can control a CD audio using voice commands.

▶ **Voice Control Operation** P. 5

Audio Screen Control



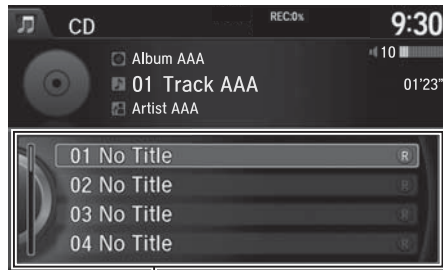

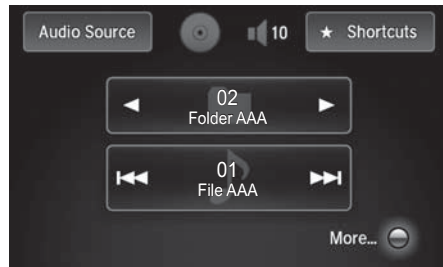

Control the audio system through the navigation screen and touchscreen.







Track list



Interface Dial

1. Rotate  or press  to display the song list.
2. Rotate , move  or  to select a file from the list. Press .
 - ▶ Press MENU button to display the menu items
 - ▶ **Audio Menu** P. 149

Touchscreen

1. Select  to skip to the next folder, and  to skip to the beginning of the previous folder in MP3, WMA, or AAC.
2. Select  or  to change tracks (files in MP3, WMA, or AAC). Select and hold to move rapidly within a track/file.
 - ▶ Select **More** to display the menu item.
 - ▶ **Audio Menu** P. 149

Audio Menu

Interface Dial

🔑 MENU button (in CD mode)



Rotate 🔄 select an item. Press 🕒.

The following items are available, depending on the type of disc:

- **Scan:**
 - Scan Folders** (MP3/WMA/AAC): Provides 10-second sampling of the first file in each of the main folders.
 - Scan Tracks:** Provides 10-second sampling of all tracks on the CD (all files in the current folder in MP3, WMA, or AAC).
- **Random/Repeat:**
 - Repeat Folder** (MP3/WMA/AAC): Repeats all files in the current folder.
 - Repeat Track:** Repeats the current track/file.
 - Random in Folder** (MP3/WMA/AAC): Plays all files in the current folder in random order.
 - Random All Tracks:** Plays all tracks/files in random order.

- **Change Source:** Changes the audio source mode.
- **Rec to HDD:** Records a music CD onto the HDD for playback using HDD Audio.
 ▶ **Recording a Music CD to HDD** P. 166
- **Music Search:** Selects a file from the Music Search list.
 ▶ **How to Select a File from the Music Search List (MP3/WMA/AAC)** P. 162

Touchscreen

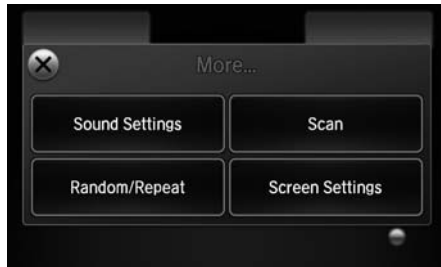

1. Select **More**.
2. Select a setting item.



The following items are available, depending on the type of disc:

- **Sound Settings:** Displays the sound preferences screen.
 ▶ **Adjusting the Sound** P. 145
- **Random/Repeat:**
Random All Tracks: Plays all tracks/files in random order.
Repeat Track: Repeats the current track/file.
- **Scan:** Provides 10-second sampling of all tracks on the CD (all files in the current folder in MP3, WMA, or AAC).
- **Screen Settings:** Displays the screen preferences screen.
 ▶ **Changing the Screen Settings** P. 82

■ How to Select a File from the Music Search List (MP3/WMA/AAC)

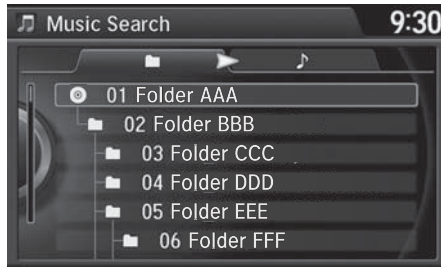
🔍 MENU button (in CD mode) ▶ **Music Search**



Rotate , move  or  to select a file from the Music Search list. Press



Recommended CDs

- Use only high-quality CD-R or CD-RW discs labeled for audio use.
- Use only CD-R or CD-RW discs on which the recordings are closed.
- Play only standard round-shaped CDs.

The CD packages or jackets should have one of these marks.



Also includes:



CDs with MP3, WMA or AAC files

- Some software files may not allow for audio play or text data display.
- Some versions of MP3, WMA or AAC formats may be unsupported.

▶▶ Recommended CDs

A Dual-disc cannot play on this audio unit. If recorded under certain conditions, a CD-R or CD-RW may not play either.

■ Protecting CDs

Follow these precautions when handling or storing CDs:

- Store a CD in its case when it is not being played.
- When wiping a CD, use a soft clean cloth from the center to the outside edge.
- Handle a CD by its edge. Never touch either surface.
- Never insert foreign objects into the CD player.
- Keep CDs out of direct sunlight and extreme heat.
- Do not place stabilizer rings or labels on the CD.
- Avoid fingerprints, liquids, and felt-tip pens on the CD.

▶ Protecting CDs

NOTICE

Do not insert a damaged CD. It may be stuck inside and damage the audio unit.

Examples:

- Bubbled, wrinkled, labeled, and excessively thick CDs



Bubbled/
Wrinkled



With Label/
Sticker



Using
Printer Label
Kit



Sealed



With Plastic Ring

- Damaged CDs



Chipped/
Cracked

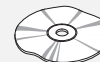

Warped



Burrs

- Poor quality CDs

- Small CDs





3-inch
(8-cm)
CD

The Hard Disc Drive (HDD) Audio function plays tracks from music CDs that have been recorded onto the built-in HDD. You can arrange the tracks in playlists or play the tracks using various search methods.

Selecting HDD Mode

Interface Dial

1. Press the MENU button. (in AUDIO mode)
2. Rotate  to select **Change Source**. Press .
3. Rotate to select **HDD**. Press to play tracks stored on the HDD.
 - ▶ Title information is displayed if found in the Gracenote® Album Info (Gracenote® Media Database) stored on the HDD.
 - ▶ The HDD has two types of playlists: original playlists and user playlists. An original playlist is automatically created for each album when a music CD is recorded. You can customize up to six user playlists provided on the HDD by adding tracks from your original playlists.

Touchscreen

1. Select **Audio Source**.
2. Select the **HDD** icon to play tracks stored on the HDD.

▶▶ Playing Hard Disc Drive (HDD) Audio

You can control the HDD audio using voice commands.

▶▶ **Voice Control Operation** P. 5

▶▶ **Song By Voice™ (SBV)** P. 184

Music tracks recorded on HDD cannot be recorded onto CDs or other devices.

Tracks are recorded at four times the playback speed using ultra-efficient compression technology; therefore, sound quality may vary slightly from the original.

If the HDD is ever replaced, all music data is lost and cannot be recovered.

If there is a problem, you may see an error message on the display.

▶▶ **Hard Disc Drive (HDD) Audio** P. 286

Recording a Music CD to HDD

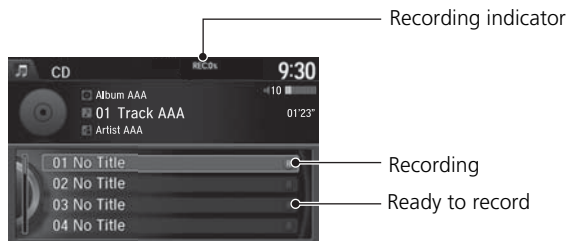

The songs on music CDs are automatically recorded by factory default to the HDD the first time you play each disc. You can then play the songs directly from the HDD.



■ Stopping Recording

1. Press the MENU button. (in CD mode)
2. Rotate  to select **Cancel Record to HDD**. Press .

■ Recording a CD Manually

1. Press the MENU button. (in CD mode)
2. Rotate  to select **Rec to HDD**. Press .

▶▶ Recording a Music CD to HDD

You can add tracks to user playlists, where you can mix and match tracks from other CDs recorded on the HDD.

▶▶ **Editing an Album or Playlist** P. 171

▶▶ **Editing Track Information** P. 173

If you stop the engine or the power system is turned off while recording a CD, there may be pauses between songs when you play back from the HDD.

Repeat, random, and scan functions are not available during recording.

You can play music from other sources (e.g., XM, HDD, etc.) while recording.

Please note that there is no compensation offered in the case of unsuccessful recording of audio data or the loss of audio data due to any cause whatsoever.

▶▶ **Clearing the HDD**

Any music tracks stored on the HDD can be deleted.

Audio Screen Control

Control the audio system through the navigation screen and touchscreen.

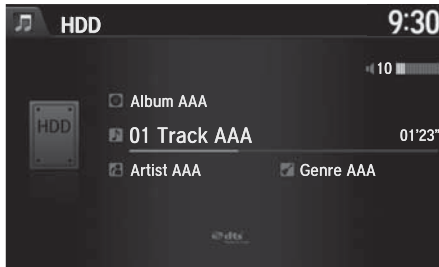

Interface Dial

1. Rotate or press to display the song list.
2. Rotate , move or to select a track from the list. Press .

▶ Press MENU button to display the menu items

▶ **Audio Menu** P. 149

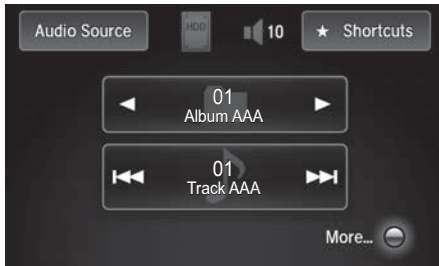

Touchscreen

1. Select skip to the next playlist/album, and to skip to the beginning of the previous playlist/album.
2. Select or to change tracks.

▶ Select and hold to move rapidly within a track.

▶ Select More to display the menu item.

▶ **Audio Menu** P. 149

Audio Menu

Interface Dial

 MENU button (in HDD mode)



Rotate  to select an item. Press .

The following items are available:

- **Scan:**
 - Scan Albums:** Provides 10-second sampling of the first track in each album.
 - Scan Tracks:** Provides 10-second sampling of all tracks on HDD.
- **Music Search:** Selects a file from the Music Search list.
 -  **How to Select a Track from the Music Search List** P. 170
- **Change Source:** Changes the audio source mode.
- **Random/Repeat:** The following menu items vary depending on the category you selected by the Music Search list.
 - Repeat Artist:** Repeats all tracks in the current artist.
 - Repeat Album:** Repeats all tracks in the current album.
 - Repeat Track:** Repeats the current track.
 - Random in Artist:** Plays all tracks in the current artist in random order.
 - Random in Album:** Plays all tracks in the current album in random order.
 - Random All Tracks:** Plays all tracks in random order.
- **Edit/Delete:** Change the playlist name, album name, genre, and track order of the current playlist. You can also delete tracks, playlists, and albums.

Touchscreen

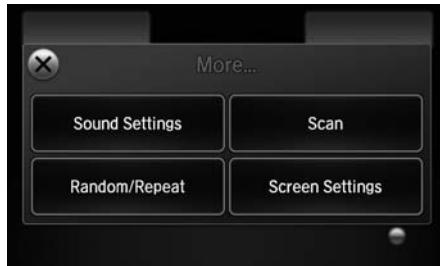

1. Select **More**.
2. Select a setting item.



The following items are available:

- **Sound Settings:** Displays the sound preferences screen.
 ▶ **Adjusting the Sound** P. 145
- **Random/Repeat:** The following menu items vary depending on the category you selected by the Music Search list.
 - Repeat Artist:** Repeats all tracks in the current artist.
 - Repeat Album:** Repeats all tracks in the current album.
 - Repeat Track:** Repeats the current track.
 - Random in Artist:** Plays all tracks in the current artist in random order.
 - Random in Album:** Plays all tracks in the current album in random order.
 - Random All Tracks:** Plays all tracks in random order.
- **Scan:**
 - Scan Albums:** Provides 10-second sampling of the first track in each album.
 - Scan Tracks:** Provides 10-second sampling of all tracks on HDD.
- **Screen Settings:** Displays the screen preferences screen.
 ▶ **Changing the Screen Settings** P. 82



■ How to Select a Track from the Music Search List

 MENU button (in HDD mode) ▶ **Music Search**

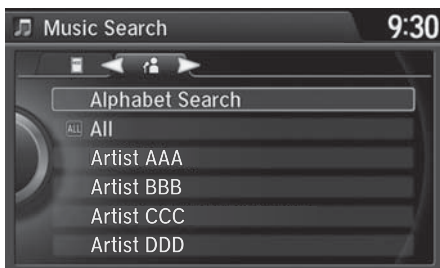

1. Move  or  to select a search category. Press .



2. Rotate  to select a track from the Music Search list. Press .

■ Editing an Album or Playlist

🔊 MENU button (in HDD mode) ▶ **Edit/Delete**

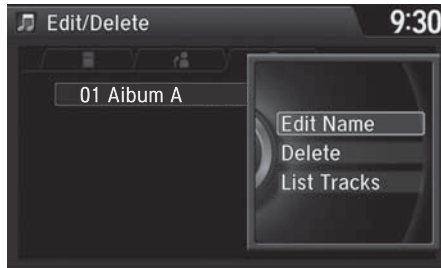

1. Rotate 🔄 to select **Albums or Playlist**. Press 🗑️.
2. Rotate 🔄 to select an album or playlist that you want edit or delete. Press 🗑️.
 - ▶ The pop-up menu appears on the screen.
3. Rotate 🔄 to select an item. Press 🗑️.

The following items are available:

- **Edit Name:** Enter a new name using the interface dial or the touchscreen.
- **Delete:** Deletes the selected album or playlist.
- **List Tracks:** Change the track title, artist name, genre and composer. You can also delete tracks.

▶▶▶ Editing an Album or Playlist

The maximum number of songs in each of the six user playlists is 999. Adding new songs overwrites the oldest songs.

The maximum number of original playlists is 999 with a maximum of 99 songs in each playlist.

Each album CD counts as an original playlist. Adding a track from a user playlist into the same user playlist will cause the track to appear twice in the playlist.

Deleting an album (original playlist) also deletes the album tracks you have stored in any user playlists.

Deleting a user playlist or deleting all tracks from a user playlist does not remove the playlist folder. The folder retains the playlist name and artist information.

■ Creating a new Playlist

🔍 MENU button (in HDD mode) ▶ **Edit/Delete** ▶ **Playlists** ▶ **Create New Playlist**



1. Enter the playlist name using the interface dial or the touchscreen.
2. Select tracks from the music search list.

■ Editing Track Information

🔍 MENU button (in HDD mode) ▶ **Edit/Delete** ▶ **Tracks**

Change the track title, artist name, genre and composer. You can also delete tracks.

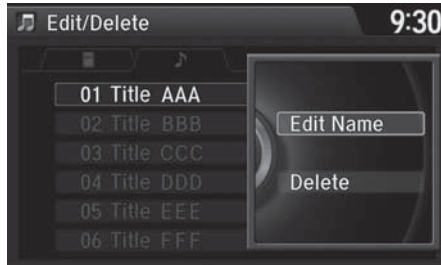

Rotate 🔄 select a track you want to edit or delete. Press 🔄.

▶ The pop-up menu appears on the screen.

The following items are available:



- **Edit Name:** Enter the track information (track name, track artist, etc.) using the interface dial or the touchscreen.
- **Delete:** Deletes a track.

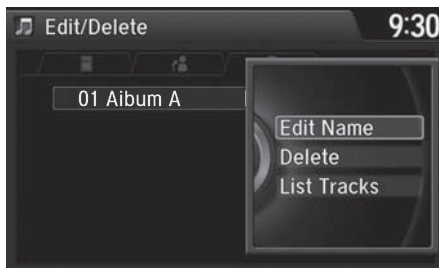

■ Displaying Music Information

 MENU button (in HDD mode) ▶ **Edit/Delete**



Music information (album name, artist name, genre) can be acquired by accessing the Gracernote® Album Info.



1. Rotate  to select **Albums**. Press .

2. Rotate  to select an album that you want edit or delete. Press .

▶ The pop-up menu appears on the screen.

3. Rotate  to select **Edit Name**. Press .

4. Move  to select **Get Music Info**. Press .

▶ The system starts to access the Gracernote® Album Info.

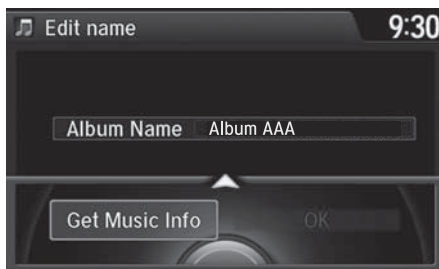

■ Updating Gracenote® Album Info

🔊 SETTINGS button (in HDD mode) ▶ **Audio Settings**

Update the Gracenote® Album Info (Gracenote® Media Database) that is included with the navigation system.



1. Insert the update disc into the disc slot or connect the USB flash drive that includes the update.
2. Rotate 🔄 to select **Update Gracenote Album Info**. Press 🗑.
3. Rotate 🔄 to select **Update by CD** or **Update by USB**. Press 🗑.
 - ▶ The system starts updating and the confirmation message appears on the screen. Press to finish 🗑.

⌘ Updating Gracenote® Album Info

To acquire updated files:

- Consult a dealer.
- Visit <http://www.navteq.com/gracenote/honda>.

Once you perform an update, any information you edited before will be overwritten or erased.

■ Deleting all HDD Data

🔧 SETTINGS button ▶ **Audio Settings** ▶ **Delete all HDD Data**

Delete all music data on the HDD.

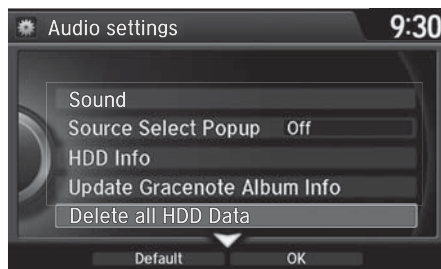

Rotate  to select **Yes**. Press .

■ Connecting an iPod®

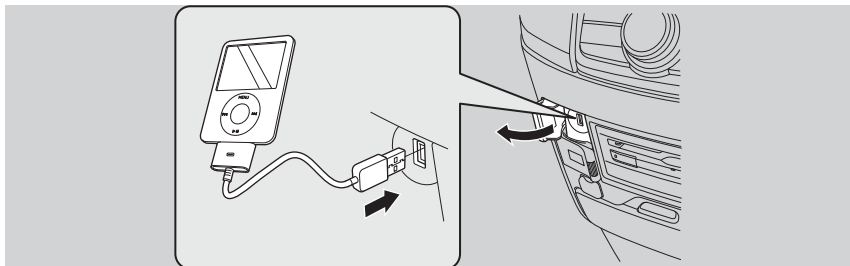

1. Open the USB cover.
2. Install the iPod® dock connector to the USB connector.

■ Model Compatibility

Model
iPod (5th generation)
iPod classic 80GB/160GB (launch in 2007)
iPod classic 120GB (launch in 2008)
iPod classic 160GB (launch in 2009)
iPod nano (1st to 6th generation) launch in 2010
iPod touch (1st to 4th generation) launch in 2010
iPhone 3G/iPhone 3GS/iPhone 4/iPhone 4S

☒ Connecting an iPod®

- Do not connect your iPod® using a hub.
- Do not use a device such as a card reader or hard disk drive, as the device or your tracks may be damaged.
- We recommend backing up your data before using the device in your vehicle.
- Displayed messages may vary depending on the device model and software version.

Your audio system may not work with all software versions of these devices.





If the audio system does not recognize your iPod®, try reconnecting it a few times or reboot the device.

State or local laws may prohibit the operation of handheld electronic devices while operating a vehicle.

Selecting iPod® Mode

1. Connect the iPod® to the USB adapter cable in the console compartment.

Interface Dial

2. Press the MENU button. (in AUDIO mode)
3. Rotate , select **Change Source**. Press .
4. Rotate , select **iPod**. Press .

Touchscreen

2. Select **Audio Source**.
3. Select the **iPod** icon.

▶▶ Playing an iPod®

You can control an iPod® using voice commands.

▶ **Voice Control Operation** P. 5

▶ **Song By Voice™ (SBV)** P. 184

Available operating functions vary on models or versions. Some functions may not be available on the vehicle's audio system.

If there is a problem, you may see an error message on the navigation screen.

▶ **iPod®/USB Flash Drive** P. 287





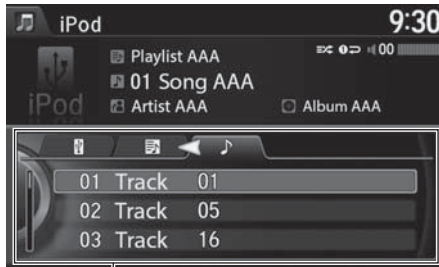

Audio Screen Control

Control the audio system through the navigation screen and touchscreen.



Track list

Interface Dial

1. Rotate  or press  to display the song list.
2. Rotate , move  or  to select a song from the list. Press .

▶ Press MENU button to display the menu items.

▶ **Audio Menu** P. 149

▶▶ Audio Screen Control

This function may not be available depending on models or versions.

Select  to go back to the previous screen.

Touchscreen

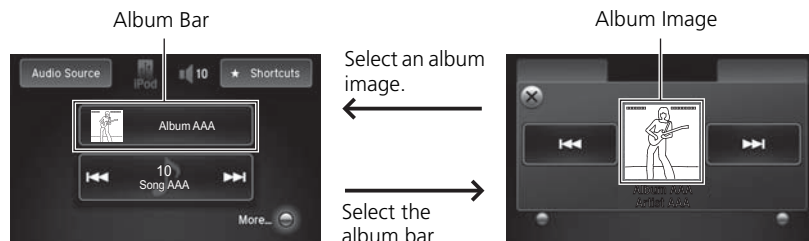

1. Select the album bar.
 - ▶ The image of the current album is displayed.
2. Select **⏮** or **⏭** to search for an album.
 - ▶ When the album image you are looking for appears, select it to play.
 - ▶ Select **More** to display the menu item.
➔ **Audio Menu P. 149**

Audio Menu

Interface Dial

🔍 MENU button (in iPod® mode)



Rotate 🔄 to select an item. Press 🏠.

The following items are available:

- **Music Search:** Selects a song from the Music Search list.
 ➤ **How to Select a Song from the Music Search List** P. 183
- **Change Source:** Changes the audio source mode.
- **Shuffle/Repeat:**
 - Repeat Song:** Repeats the current track.
 - Shuffle Albums:** Plays all available albums in a selected list (playlists, artists, albums, songs, genres, or composers) in random order.
 - Shuffle All Songs:** Plays all available files in a selected list (playlists, artists, albums, songs, genres, or composers) in random order.

Touchscreen

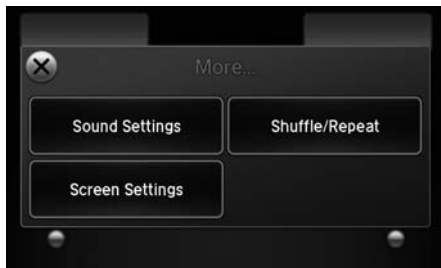

1. Select **More**.
2. Select a setting item.

The following items are available:

- **Sound Settings:** Displays the sound preferences screen.
▶ **Adjusting the Sound** P. 145
- **Shuffle/Repeat:**
Repeat Song: Repeats the current track.
Shuffle Albums: Plays all available albums in a selected list (playlists, artists, albums, songs, genres, or composers) in random order.
Shuffle All Songs: Plays all available files in a selected list (playlists, artists, albums, songs, genres, or composers) in random order.
- **Screen Settings:** Displays the screen preferences screen.
▶ **Changing the Screen Settings** P. 82

■ How to Select a Song from the Music Search List

🔍 MENU button (in iPod® mode) ▶ **Music Search**

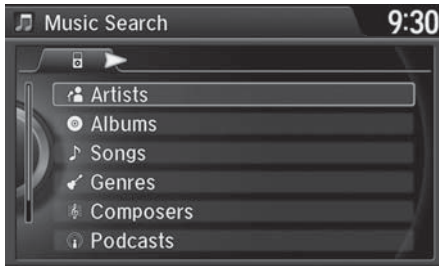

1. Move ◀○ or ○▶ to select a search category. Press 🔍.

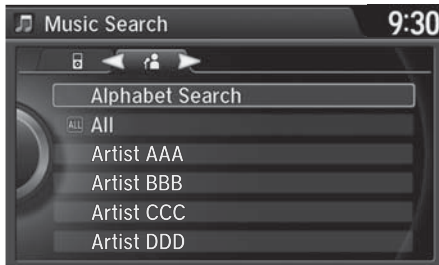

2. Rotate 🔍 to select a file from the Music Search list. Press 🔍.

Song By Voice™ (SBV)

Use SBV to search for and play music from your HDD or iPod® using voice commands.

■ Settings Song By Voice™ (SBV)

🔑 SETTINGS button ▶ **System Settings** ▶ **Song by Voice**







Rotate  to select **On** or **Off**. Press .

The following items are available:

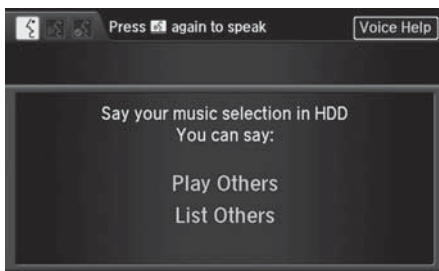
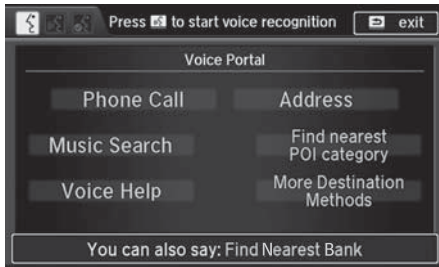
- **On** (factory default): Song By Voice commands are available.
- **Off**: Disable the feature.

■ Searching for music using Song By Voice™ (SBV)



1. Set the **Song by Voice** setting to **On**.
2. Press the  (Talk) button and say *"Music Search"* to activate the SBV feature for the HDD and iPod®.
3. Press the  button and say a command.
 - ▶ Example 1: Say "(List) 'Artist A'" to view a list of songs by that artist. Select the desired song to start playing.
 - ▶ Example 2: Say "Play 'Artist A'" to start playing songs by that artist.
4. To cancel SBV, press the  (hang-up/back) button on the steering wheel. The selected song continues playing.

▶▶ Searching for music using Song By Voice™ (SBV)

Song By Voice™ Commands List

▶ **Song By Voice™ commands** P. 312

NOTE:

Song By Voice™ commands are available for tracks stored on the HDD or iPod®.

You can add phonetic modifications of difficult words so that it is easier for SBV to recognize artists, songs, albums, and composers in voice commands.

▶ **Phonetic Modification** P. 186

SBV may not be able to recognize languages other than English for the artist name, song title, album title, and composers.

Once you have canceled this mode, you need to press the  button and say "Music Search" again to re-activate this mode.

■ Phonetic Modification

🔊 SETTINGS button ▶ **System Settings** ▶ **Song by Voice Phonetic Modification**

Add phonetic modifications of difficult or foreign words so that it is easier for SBV to recognize artists, songs, albums, and composers in voice commands when searching for music on the HDD or iPod®.



1. Move 🔄 and 🔄 rotate to select **New Modification**. Press 🔄.











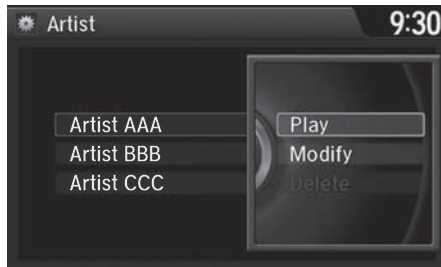

2. Rotate 🔄 to select **HDD** or **iPod**. Press 🔄.

☒ Phonetic Modification



Phonetic Modification is grayed out when Song By Voice is set to **Off**.

You can store up to 2,000 phonetic modification items.



3. Rotate  to select the item to modify (e.g., **Artist**). Press .
 - ▶ The list of the selected item appears on the screen.
4. Rotate  to select an entry (e.g., **No Name**). Press .
 - ▶ The pop-up menu appears on the screen.
5. Rotate  to select **Modify**. Press .
 - ▶ To listen to the current phonetic modification, rotate  to select **Play**. Press .
 - ▶ To delete the current phonetic modification, rotate  to select **Delete**. Press .







6. Enter the phonetic spelling you wish to use (e.g., "Artist A") when prompted.
7. Move  to select OK to exit. The artist "No Name" is phonetically modified to "Artist A." When in the SBV mode, you can press the  (Talk) button and use the voice command "Play 'Artist A'" to play songs by the artist "No Name."

Selecting Internet Radio Mode

1. Connect a compatible phone through *Bluetooth*®.

Interface Dial

2. Press the MENU button.(in AUDIO mode)
3. Rotate  to select **Change Source**. Press .
4. Rotate  to select **Pandora** or **Aha**. Press .

Touchscreen

2. Select **Audio Source**.
3. Select the **Pandora** or **Aha** icon.

iPhone®

You can also connect the phone using your dock connector to the USB port.

▶▶ Playing internet Radio

Pandora®, the Pandora logo, and the Pandora trade dress are trademarks or registered trademarks of Pandora Media, Inc., used with permission. Pandora is currently available exclusively in the United States.

To find out if your phone is compatible with this feature, visit www.handsfreelink.honda.com, or call 1-888-528-7876.

Pandora® is a personalized Internet radio service that selects music based on an artist, song, or genre a user enters, and streams what is likely to be of interest.

To use this service in your vehicle, the Pandora® app must first be installed on your phone. Visit www.pandora.com. for more information.

If you cannot operate Pandora® through the audio system, it may be streaming through *Bluetooth*® Audio.

Make sure Pandora® mode on your audio system is selected.

Pandora® Menu



The following items are available:

- Skip Forward
- Play/Pause
- Station List
- Like



Interface Dial







Rotate  to select an item. Press .

▶ Press MENU button to display the menu items.

- ▶ **Selecting Internet Radio Mode**
P. 189

- Dislike
- Bookmark Track
- Bookmark Artist

Touchscreen

1. Select  or  to change a station.
2. Select  to skip a song.
 - ▶ Select  to resume or play a song.
 - ▶ Select  or  to evaluate a song.
 - ▶ Select **More** to display the menu item.
 - ▶ **Adjusting the Sound** P. 145
 - ▶ **Changing the Screen Settings** P. 82

▶▶ Pandora® Menu

You can control Pandora® using voice commands.

- ▶ **Voice Control Operation** P. 5

Available operating functions vary on software versions. Some functions may not be available on the vehicle's audio system.

If there is a problem, you may see an error message on the navigation screen.

- ▶ **Pandora®** P. 288

There are restrictions on the number of songs you can skip or dislike in a given hour.

Aha™ Radio Menu



The following items are available:

- Like
- Dislike
- Play/Pause
- 15sec Back

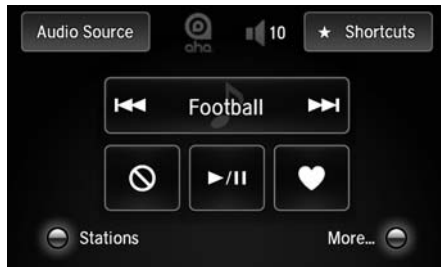

Interface Dial

Rotate  to select an item. Press .



▶ Press MENU button to display the menu items.

▶ Selecting Internet Radio Mode

P. 189

- 30sec skip
- View text
- View list
- Reply

Touchscreen

3. Select  or  to change a station.

4. Select  or  to skip contents.

▶ Select  to resume or play a song.

▶ Select an icon to evaluate a song.

▶ Select **More** to display the menu item.

▶ Adjusting the Sound P. 145

▶ Changing the Screen Settings P. 82

▶ Aha™ Radio Menu

Aha™ by Harman is a cloud-based service that organizes your favorite web content into live radio stations. You can access podcasts, internet radio, location-based services, and audio updates from social media sites.

You can control Aha™ Radio using voice commands.

▶ Voice Control Operation P. 5

Available operating functions vary on software versions. Some functions may not be available on the vehicle's audio system.

If there is a problem, you may see an error message on the navigation screen.

▶ Aha™ Radio P. 289

The menu items vary depending on the station you selected.

To use this service in your vehicle, the HondaLink app must be installed on your phone. Visit owners.honda.com/apps for more information.

You must have a previously set up Aha account prior to using the service in your vehicle. Visit www.aharadio.com for more information.

To display stations on the screen, they must be previously stored as favorites in the Aha app.

■ How to Select a Station from the Station List

🔊 MENU button (in Aha™ mode) ▶ **Stations**



Rotate 🔄 to select a station from the Station list. Press 🗑️.

■ Connecting a USB Flash Drive

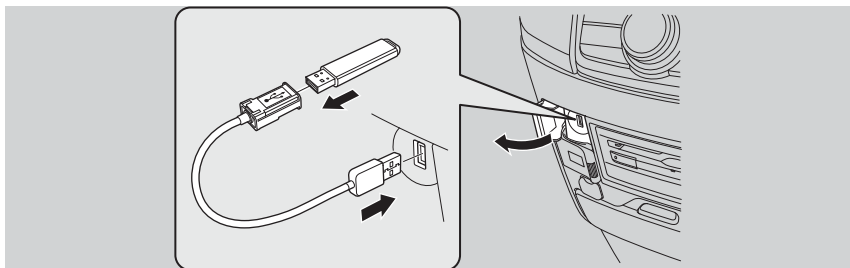

1. Open the USB cover.
2. Install the USB flash drive to the USB connector.

■ USB Flash Drives

Use a recommended USB flash drive of 256 MB or higher.

Some digital audio players may not be compatible.

Some USB flash drives (e.g., a device with security lockout) may not work.

Some software files may not allow for audio play or text data display.

Some versions of MP3, WMA, or AAC formats may be unsupported.

⊗ Connecting a USB Flash Drive

- Do not connect your USB flash drive using a hub.
- Do not use a device such as a card reader or hard disk drive, as the device or your tracks may be damaged.
- We recommend backing up your data before using the device in your vehicle.

⊗ USB Flash Drives





Digital music tracks, such as MP3, WMA, AAC, etc., in USB flash drives cannot be copied to HDD. Likewise, digital music tracks recorded to HDD cannot be copied to USB flash drives.

Files on the USB flash drive are played in their stored order. This order may be different from the order displayed on your PC or device.

Selecting USB Mode

1. Connect the USB flash drive to the USB port in the console compartment.

Interface Dial

2. Press the MENU button. (in AUDIO mode)
3. Rotate  to select **Change Source**. Press .
4. Rotate  to select **USB**. Press .

Touchscreen

2. Select **Audio Source**.
3. Select the iPod icon.

▶▶ Playing a USB Flash Drive

You can control a USB flash drive using voice commands.

▶▶ **Voice Control Operation** P. 5

Files in WMA/ACC format protected by digital rights management (DRM) cannot be played.

The audio system displays Unplayable File, and then skips to the next file.

If there is a problem, you may see an error message on the navigation screen.





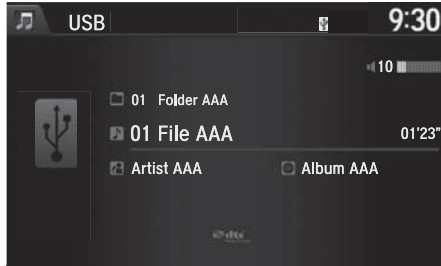

▶▶ **iPod®/USB Flash Drive** P. 287

Audio Screen Control

Control the audio system through the navigation screen and touchscreen.



Interface Dial





1. Rotate  or press  to display the song list.
2. Rotate , move  or  to select a song from the list. Press .

▶ Press MENU button to display the menu items

➤ **Audio Menu** P. 149



Touchscreen

1. Select  to skip to the next folder, and  to skip to the beginning of the previous folder.
2. Select  or  to change files. Select and hold to move rapidly within a file.

▶ Select **More** to display the menu item.

➤ **Audio Menu** P. 149

Audio Menu

Interface Dial

 MENU button (in USB mode)



Rotate  to select an item. Press .

The following items are available:

- **Scan:**
 - Scan Folders:** Provides 10-second sampling of the first file in each of the main folders.
 - Scan Tracks:** Provides 10-second sampling of all files in the current folder.
- **Random/Repeat:**
 - Repeat Folder:** Repeats all files in the current folder.
 - Repeat Track:** Repeats the current file.
 - Random in Folder:** Plays all files in the current folder in random order.
 - Random All Tracks:** Plays all files in random order.
- **Change Source:** Changes the audio source mode.
 - **Selecting Disc Mode** P. 158
- **Music Search:** Selects a file from the Music Search list.
 - **How to Select a File from the Music Search List** P. 198

Touchscreen

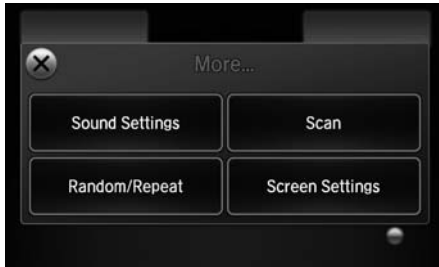

1. Select **More**.
2. Select a setting item.



The following items are available:

- **Sound Settings:** Displays the sound preferences screen.
 ▶ **Adjusting the Sound** P. 145
- **Random/Repeat:**
 Repeat Folder: Repeats all files in the current folder.
 Repeat Track: Repeats the current file.
 Random in Folder: Plays all files in the current folder in random order.
 Random All Tracks: Plays all files in random order.
- **Scan:**
 Scan Folders: Provides 10-second sampling of the first file in each of the main folders.
 Scan Tracks: Provides 10-second sampling of all files in the current folder.
- **Screen Settings:** Displays the screen preferences screen.
 ▶ **Changing the Screen Settings** P. 82

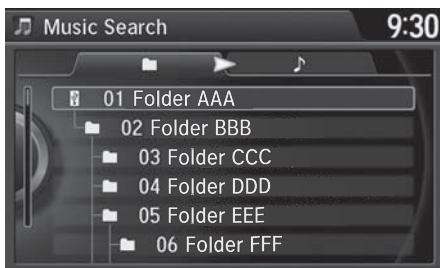

■ How to Select a File from the Music Search List

 MENU button (in USB mode) ▶ **Music Search**



1. Move  or  to select a search category. Press .



2. Rotate  to select a file from the Music Search list. Press .

Your audio system allows you to listen to music from your *Bluetooth*®-compatible phone.

This function is available when the phone is paired and connected to the vehicle's *Bluetooth*® HandsFreeLink® (HFL) system.

➤ ***Bluetooth*® HandsFreeLink®** P. 204

Selecting *Bluetooth*® Audio Mode

1. Make sure that your phone is on, paired, and linked to HFL.

➤ **Phone Settings** P. 221

Interface Dial

2. Press the MENU button. (in AUDIO mode)

3. Rotate  to select **Change Source**. Press .

4. Rotate  to select **Bluetooth Audio**. Press .

Touchscreen

2. Select **Audio Source**.

3. Select the **Bluetooth** icon.

▶▶ Playing *Bluetooth*® Audio

Not all *Bluetooth*®-enabled phones with streaming audio capabilities are compatible with the system.

For a list of compatible phones, visit www.handsfreelink.honda.com, or call 1-888-528-7876.

State or local laws may prohibit the operation of handheld electronic devices while operating a vehicle.

If more than one phone is paired to the HFL system, there will be a delay before the system begins to play.

You can control *Bluetooth*® Audio using voicecommands.



➤ **Voice Control Operation** P. 5

Audio Screen Control

Control the audio system through the navigation screen and touchscreen.



Interface Dial

1. Press MENU button. (in BT mode)
2. Rotate  select an item. Press .

The following items are available:

- **Play:** Plays a song.
- **Pause:** Pauses a song.
- **Change Source:** Changes the audio source mode.
 - ▶ **Selecting Disc Mode** P. 158
- **Music Search:** Selects a song from the Music Search list.

▶ Audio Screen Control

To play the audio files, you may need to operate your phone. If so, follow the phone maker's operating instructions.

The pause function and Music Search may not be available on some phones.

Switching to another mode pauses the music playing from your phone. This function may not be available on some phones.

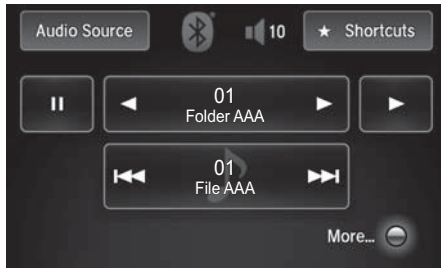

Touchscreen

1. Select ◀ or ▶ to change folders.
2. Select ◀◀ or ▶▶ to change files.
 - ▶ Select **More** to display the menu items, then select a setting item.

The following items are available:

- **Sound Settings:** Displays the sound preferences screen.
 - **Adjusting the Sound** P. 145
- **Screen Settings:** Displays the screen preferences screen.
 - **Changing the Screen Settings** P. 82

Bluetooth® HandsFreeLink®

This section describes how to operate *Bluetooth® HandsFreeLink®*. You can place and receive phone calls using your vehicle's audio system without handling your cell phone.

Bluetooth® HandsFreeLink®	204	HFL Menus.....	241
Using HFL	204		
Pairing a Phone	206		
Importing Phonebook Data	212		
Setting Up Speed Dialing	213		
Phonebook Phonetic Modification.....	216		
Phone Settings.....	221		
Making a Call	226		
Receiving a Call.....	231		
Text Message/E-mail	233		
Setting a Text Message/E-mail	233		
Selecting a Mail Account.....	235		
Receiving a Text Message/E-mail	236		
Displaying Messages	237		

Bluetooth® HandsFreeLink® (HFL) allows you to place and receive phone calls using your vehicle's navigation system, without handling your cell phone.

Using HFL

HFL Buttons

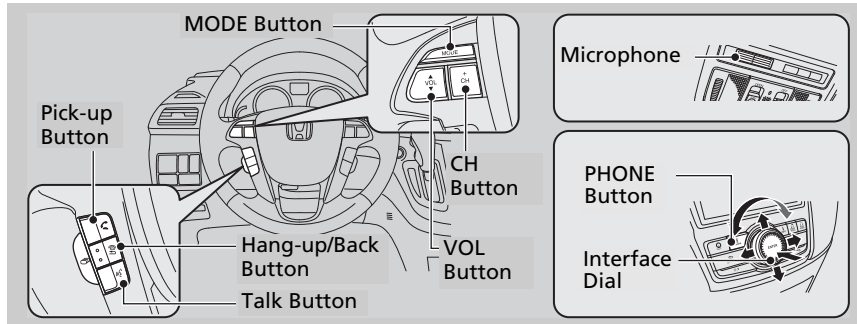







 (Pick-up) button: Press to go directly to the Phone screen or to answer an incoming call.

 (Hang-up/back) button: Press to end a call, to cancel a command or to return to the previous screen.

 (Talk) button: Press to give HFL voice commands.

PHONE button: Press to go directly to the Phone screen.

Interface dial: Rotate  to select an item on the screen, then press . Move , ,  or  to select secondary menu.

Bluetooth® HandsFreeLink®

To use HFL, you need a Bluetooth®-compatible cell phone. For a list of compatible phones, pairing procedures, and special feature capabilities:

Visit www.handsfreelink.honda.com, or call 1-888-528-7876.

Voice control tips:

- Aim the vents away from the ceiling and close the windows, as noise coming from them may interfere with the microphone.
- Press and release the  button when you want to call a number using a stored voice tag, a phonebook name, or a number. Speak clearly and naturally after a beep.
- If the microphone picks up voices other than yours, the command may be misinterpreted.
- To change the volume level, use the audio system's volume knob or the remote audio controls on the steering wheel.

State or local laws may prohibit the operation of handheld electronic devices while operating a vehicle.

If you receive a call while using the audio system, the system resumes its operation after ending the call.

HFL Status Display

The navigation screen notifies you when there is an incoming call.

Bluetooth® Indicator
Comes on when your phone is connected to HFL.

Caller's Name

Caller's Number

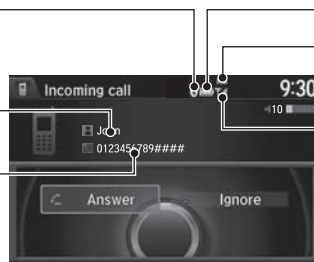

Battery Level Status

Roam Status

Signal Strength

Limitations for Manual Operation



Disabled Option

Certain manual functions are disabled or inoperable while the vehicle is in motion.

You cannot select a grayed-out option until the vehicle is stopped.

Only previously stored speed dial entries with voice tags, phonebook names, or numbers can be called using voice commands while the vehicle is in motion.

▶ **Setting Up Speed Dialing** P. 213

Bluetooth® HandsFreeLink®

Bluetooth® Wireless Technology

The *Bluetooth®* word mark and logos are registered trademarks owned by Bluetooth SIG, Inc., and any use of such marks by Honda Motors Co., Ltd., is under license. Other trademarks and trade names are those of their respective owners.

HFL Status Display

The information that appears on the navigation screen varies between phone models.

You can change the system language to English, French, or Spanish.

▶ **Language Settings** P. 33

Pairing a Phone

PHONE button

When no Bluetooth®-compatible phone has ever been paired, the following screen appears:

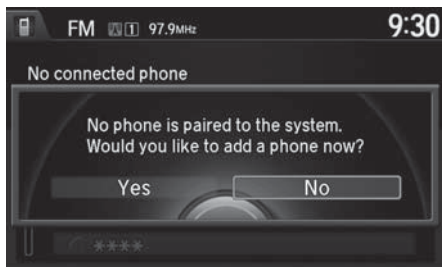

1. Rotate to select **Yes**. Press .
2. Make sure your phone is in search or discoverable mode. Press .
 - ▶ HFL automatically searches for a Bluetooth® device.
3. When your phone appears on the list, select it by pressing .
 - ▶ If your phone does not appear, you can select **Refresh** to search again.
 - ▶ If your phone still does not appear, move to select **Phone not Found?** and search for Bluetooth® devices using your phone. From your phone, select **HandsFreeLink**.

▶▶ Pairing a Phone

Your Bluetooth®-compatible phone must be paired to HFL before you can make and receive hands-free calls.

Phone Pairing Tips:

- You cannot pair your phone while the vehicle is moving.
- Up to six phones can be paired.
- Your phone's battery may drain faster when it is connected to HFL.
- If your phone is not ready for pairing or not found by the system within three minutes, the system will time out and returns to idle.

Once you have paired a phone, you can see it displayed on the screen with one or two icons on the right side.

These icons indicate the following:

: The phone can be used with HFL.

: The phone is compatible with Bluetooth® Audio.



4. HFL gives you a pairing code on the navigation screen.
 - ▶ Confirm if the pairing code on the screen and your phone match. This may vary by phone.
5. You will receive a notification on the screen if pairing is successful.

▶▶ Pairing a Phone



When pairing is completed, an **Automatic Phone Sync** prompt appears. Select **On** if you want your call history and phonebook automatically imported to HFL.

▶▶ **Automatic Phone Sync setting** P. 225

■ Pairing from Phone Setup



SETTINGS button ▶ **Phone Settings** ▶ **Connect Phone**



1. Rotate  to select **Add Bluetooth Device**.
2. Make sure your phone is in search or discoverable mode. Press .
 - ▶ HFL automatically searches for a *Bluetooth®* device.

Continued





3. When your phone appears on the list, select it by pressing 
 - ▶ If your phone does not appear, you can select **Refresh** to search again.
 - ▶ If your phone still does not appear, move  to select **Phone not Found?** and search for *Bluetooth*® devices using your phone. From your phone, select **HandsFreeLink**.
4. HFL gives you a pairing code on the navigation screen.
 - ▶ Confirm if the pairing code on the screen and your phone match. This may vary by phone.
5. You will receive a notification on the screen if pairing is successful.

■ Changing the Pairing Code

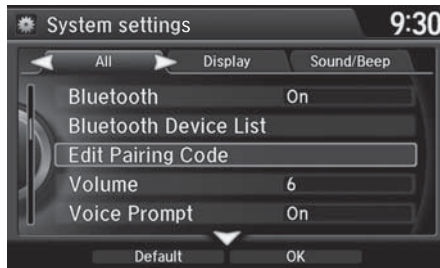
🔧 SETTINGS button ▶ **System Settings**



1. Rotate  to select **Edit Pairing Code**. Press .



2. Rotate  to select **Fixed** or **Random**. Press .

☒ Changing the Pairing Code

The pairing code may be six or four digits depending on your phone.

The default pairing code is **0000** until you change the setting.

To create your own, select **Fixed**, and delete the current code, then enter a new one.

For a randomly generated pairing code each time you pair a phone, select **Random**.

■ Changing the Currently Paired Phone

📶 SETTINGS button ▶ **Phone Settings** ▶ **Bluetooth Device List**



1. Rotate 📶 to select a paired phone you want to replace. Press 📶.
2. Rotate 📶 to select **Replace This Device**. Press 📶.
3. HFL enters the pairing process and searches a new phone.
 - ▶ Follow the prompts to pair a new phone.
4. You will receive a notification on the screen if pairing is successful.





▣ Changing the Currently Paired Phone

The replaced phone will keep the same speed dial entries, and security PIN information from the previously paired phone.



Deleting a Paired Phone

SETTINGS button ▶ Phone Settings ▶ Bluetooth Device List



1. Rotate  to select a paired phone you want to replace. Press .
2. Rotate  to select **Delete This Device**. Press .



3. You will receive a confirmation message on the screen. Rotate  to select **Yes**. Press .
4. You will receive a notification on the screen if deletion is successful.

Importing Phonebook Data



When your phone is paired, the contents of its phonebook and call history are automatically imported to HFL.

Importing Phonebook Data

When you select a person from the list in the cellular phonebook, you can see up to three category icons. The icons indicate what types of numbers are stored for that name.

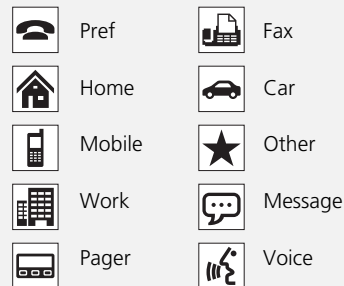

On some phones, it may not be possible to import the category icons to HFL.



The phonebook is updated after every connection. Call history is updated after every connection or call.

Setting Up Speed Dialing

 MENU button (on PHONE screen) ▶ **Speed Dial**

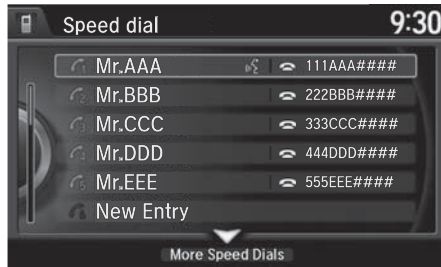
Up to 20 speed dial numbers can be stored per phone.





1. Rotate  to select **New Entry**.
Press .

▶▶ Setting Up Speed Dialing

When a voice tag is stored, press the  button to call the number using the voice tag. Say "Call" and the voice tag name.



2. Rotate  to select a number entry method. Press .

The following options are available:

- **Import from Call History:** Select a number from the call history.
- **Manual Input:** Input the number manually.
- **Import from Phonebook:** Select a number from the linked cell phone's imported phonebook.

■ Registering a Voice Tag to a Speed Dial Entry

📍 SETTINGS button ▶ **Phone Settings** ▶ **Edit Speed Dial**

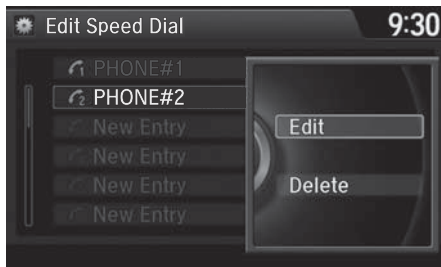

1. Select an existing speed dial entry.
2. From the pop-up menu, rotate 📶 to select **Edit**. Press 📶.

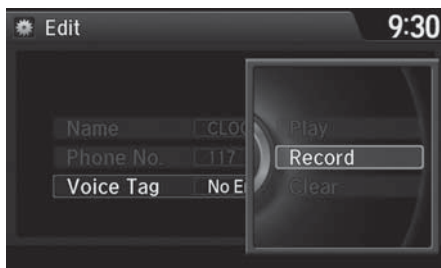

3. Rotate 📶 to select Voice Tag. Press 📶.
4. From the pop-up menu, rotate 📶 to select **Record**. Press 📶.
 - ▶ After selecting **Record**, wait for the beep(s) to sound before you say the name.
5. Move 📍 and select **OK** to complete the voice tag.

▣ Registering a Voice Tag to a Speed Dial Entry





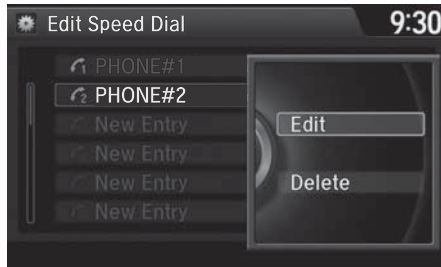

Avoid using duplicate voice tags.

Avoid using "home" as a voice tag.

It is easier for HFL to recognize a longer name. For example, use "John Smith" instead of "John."



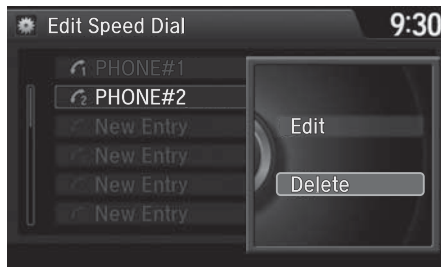

■ To delete a voice tag

1. Select an existing speed dial entry.
2. From the pop-up menu, rotate  to select **Edit**. Press .
3. Rotate  to select Voice Tag. Press .
4. From the pop-up menu, rotate  to select **Clear**. Press .
5. You will receive a confirmation message on the screen. Rotate to select **Yes**. Press .



■ To delete a speed dial

1. Select an existing speed dial entry.
2. From the pop-up menu, rotate  to select **Delete**. Press .
3. You will receive a confirmation message on the screen. Rotate to select **Yes**. Press .

Phonebook Phonetic Modification

📍 SETTINGS button ▶ **System Settings** ▶ **Phonebook Phonetic Modification**

Add phonetic modifications or a new voice tag to the phone's contact name so that it is easier for HFL to recognize voice commands.

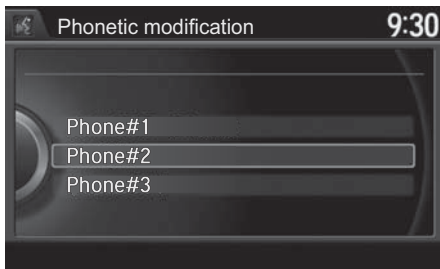

■ To add a new voice tag

1. Rotate 📶 to select the phone you want to add phonetic modification to. Press 📶.

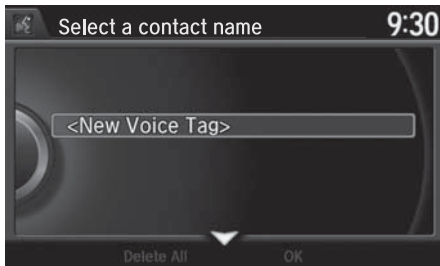

2. Rotate 📶 to select New Voice Tag. Press 📶.



☒ Phonebook Phonetic Modification

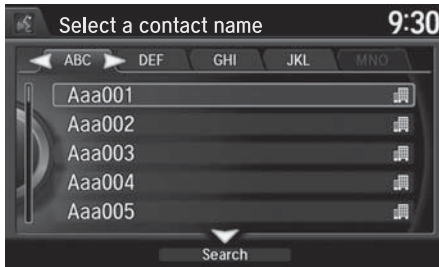

You can store up to 20 phonetic modification items.



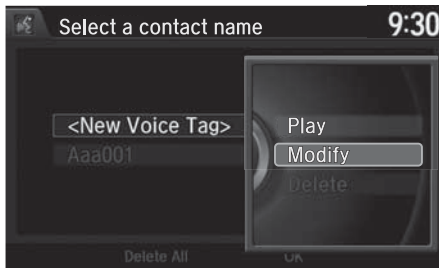

3. Move ◀○ or ○▶ and rotate  to select a contact name. Press .



▶ The pop-up menu appears on the screen.



4. Rotate  to select **Modify**. Press .







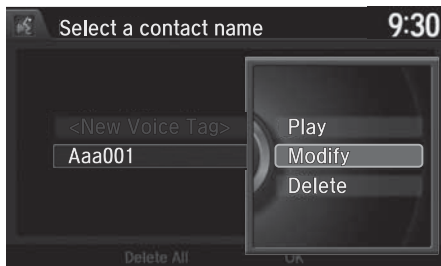

5. Using the  button, follow the prompts to complete the voice tag.

6. You will receive a confirmation message on the screen. Rotate  to select **OK**. Press .

7. The screen returns to the New Voice Tag screen. Move  and rotate  to select **OK**. Press .



■ To modify a voice tag

1. Rotate  to select the phone you want to add phonetic modification to. Press .
2. Rotate  to select a contact name you want to modify. Press 
 - ▶ The pop-up menu appears on the screen.
3. Rotate  to select **Modify**. Press .
4. Using the  button, follow the prompts to complete the voice tag.
5. You will receive a confirmation message on the screen. Rotate  to select **OK**. press .

▶▶ Phonebook Phonetic Modification

You can only modify or delete contact names for the currently connected phone.

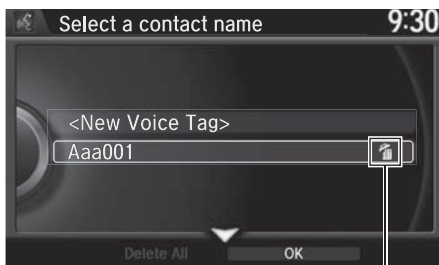
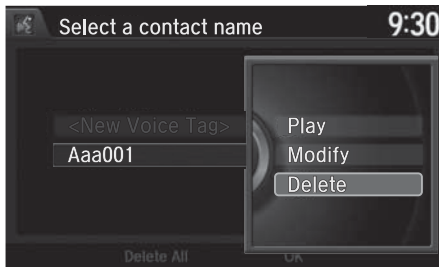



Trash icon

■ To delete a modified voice tag

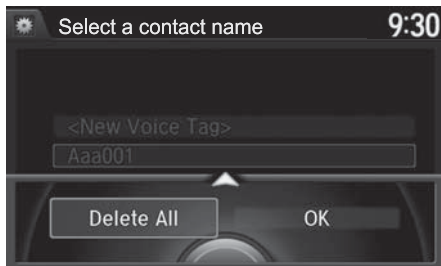
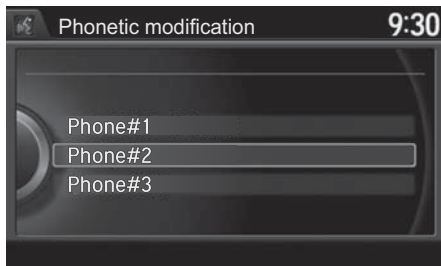

1. Rotate to select the phone you want to delete phonetic modification. Press .
2. Rotate to select a contact name you want to delete. Press .
 - ▶ The pop-up menu appears on the screen.
3. Rotate to select **Delete**, then press .
 - ▶ Items to be deleted are indicated with a trash icon.
4. Move and rotate to select OK. Press .





■ To delete all modified voice tags

1. Rotate  to select the phone you want to delete phonetic modification. Press .

▶ The contact name list appears.

2. Move  and rotate  to select **Delete All**. Press .

3. You will receive a confirmation message on the screen. Rotate  to select **OK**. Press .

Phone Settings

SETTINGS button ▶ **Phone Settings**







Set HFL options and features.

■ Editing a Security PIN

SETTINGS button ▶ **Phone Settings** ▶ **Bluetooth Device List**

You can protect each of the six cell phones with a security PIN.



1. Rotate  to select the phone you want to add a security PIN to. Press .
2. Rotate  to select **Edit PIN**. Press .
3. Enter a new four-digit number. Rotate  to select **OK** to enter the security PIN.
 - ▶ Move  to delete.
4. Re-enter the four-digit number.
 - ▶ The screen returns to the screen in step 4.

▶▶ Editing a Security PIN

If the phone is already security PIN protected, you need to enter the current security PIN before clearing the PIN or creating a new one.

■ Editing User Name

📶 SETTINGS button ▶ **Phone Settings** ▶ **Bluetooth Device List**

Edit the user name of a paired phone as follows:

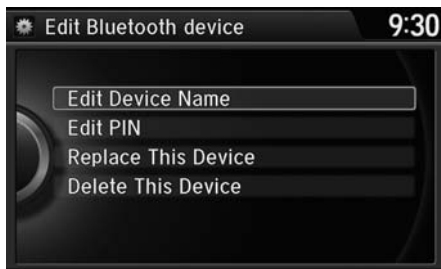

1. Rotate 📶 to select a phone you want to edit. Press 📶.

2. Rotate 📶 to select **Edit Device Name**. Press 📶.



3. Enter a new name of the phone.

▶ Rotate 📶 or move 📍 to select **OK** to enter the name. Press 📶.

▶ Move ◀ to delete.

■ Automatic Transferring

ⓘ SETTINGS button ▶ **Phone Settings** ▶ **Auto Transfer**

If you get into the vehicle while you are on the phone, the call can be automatically transferred to HFL.



Rotate  to select **On**. Press .

■ Auto Answer

ⓘ SETTINGS button ▶ **Phone Settings** ▶ **Auto Answer**

You can set HFL to automatically answer an incoming call in four seconds.



Rotate  to select **On**. Press .

■ Ring Tone

📞 SETTINGS button ▶ **Phone Settings** ▶ **Ring Tone**

You can change the ring tone setting.



Rotate 📞 to select your desired setting item. Press 📞.

The following items are available:

- **Fixed:** The fixed ring tone sounds from the speaker.
- **Mobile Phone:** The ring tone stored in the connected cell phone sounds from the speaker.
- **Off:** No ring tones sound from the speaker.

■ Automatic Phone Sync setting

🔗 SETTINGS button ▶ **Phone Settings** ▶ **Automatic Phone Sync**



Rotate  to select On or Off. Press .

■ Use Contact Photo

🔗 SETTINGS button ▶ **Phone Settings** ▶ **Use Contact Photo**

You can display a caller's picture on an incoming call screen.



Rotate  to select On. Press .

Making a Call

You can make calls by inputting any phone number, or by using the imported phonebook, call history, speed dial entries, or redial.



▶▶ Making a Call

Any voice-tagged speed dial entry, phonebook name, or number can be dialed by voice from most screens. Press the  button and say "Call" and the voice tag name, "Call by name" and the phonebook name, or "Call" and the phone number.

The maximum range between your phone and vehicles is 30 feet (10 meters).

Once a call is connected, you can hear the voice of the person you are calling through the audio speakers.

■ Using the Phonebook

📞 MENU button (on Phone Settings) ▶ **Phonebook**



1. The phonebook is stored alphabetically. Move 📍 to Search.

▶ You can use the keyboard on the touch screen for an alphabetical search.



2. Rotate 📞 to select a number. Press 📞.

▶ Dialing starts automatically.

▶▶ Using the Phonebook

This function is disabled while the vehicle is moving. However, you can call a stored voice-tagged speed dial number, phonebook name, or number using voice commands.

▶ **Limitations for Manual Operation** P. 205
 ▶ **Setting Up Speed Dialing** P. 213

■ Entering a Phone Number

📞 MENU button (on Phone Settings) ▶ **Dial**



1. Rotate 📞 to select a number. Press 📞.
2. Rotate 📞 to select [6]. Press 📞.

■ Using Redial

📞 MENU button (on Phone Settings) ▶ **Redial**

You can display a caller's picture on an incoming call screen.



- Rotate 📞 to select Dial. Press 📞.
▶ Dialing starts automatically.

☒ Entering a Phone Number

This function is disabled while the vehicle is moving. However, you can call a stored voice-tagged speed dial number, phonebook name, or number using voice commands.





- ☒ **Limitations for Manual Operation** P. 205
- ☒ **Setting Up Speed Dialing** P. 213

■ Using Call History



 MENU button (on Phone Settings) ▶ **Call History**

Call history is stored by **All**, **Dialed**, **Received**, and **Missed**.



1. Move  or  to select **All**, **Dialed**, **Received**, and **Missed**.
2. Rotate  to select a number. Press .
 - ▶ Dialing starts automatically.



Steering switches

1. Press the  button.
2. Move the left selector wheel right to select **Call History**.
3. Roll the left selector wheel to select a number.
4. Push the left selector wheel or the  button.
 - ▶ Dialing starts automatically.

▶▶ Using Call History

The call history displays the last 20 dialed, received, or missed calls.
(Appears only when a phone is connected to HFL.)

These icons next to the number indicate the following:

-  : Dialed calls
-  : Received calls
-  : Missed calls

Steering switches

The call history displays the last 12 dialed, received, or missed calls.

■ Using Speed Dial

📞 MENU button (on Phone Settings) ▶ **Speed Dial**



Rotate 📞 to select a number. Press 📞.

▶ Dialing starts automatically.

Steering switches

1. Press the 📞 button.
2. Move the left selector wheel left to select **Speed Dial**.
3. Roll the left selector wheel to select a number.
4. Push the left selector wheel or the 📞 button.
 - ▶ Dialing starts automatically.

☒ Using Speed Dial

Move 📞 to select **More Speed Dials** to view another paired phone's speed dial list. You can make a call from that list using the currently connected phone.

When a voice tag is stored, press the 📞 button to call the number using the voice tag.

➡ **Setting Up Speed Dialing** P. 213

Any voice-tagged speed dial entry, phonebook name or number can be dialed by voice from any screen. Press the 📞 button and follow the prompts.



Steering switches

The speed dial displays the 20 speed dial entries.

Receiving a Call

When there is an incoming call, an audible notification sounds (if activated) and the Incoming call screen appears.



1. Press the  button to answer the call.
2. Press the  button to decline or end the call.

▶▶ Receiving a Call

Call Waiting

Press the  button to put the current call on hold to answer the incoming call.

Press the  button again to return to the current call.



Ignore the incoming call if you do not want to answer it.

Press the  button if you want to hang up the current call.

■ Options During a Call

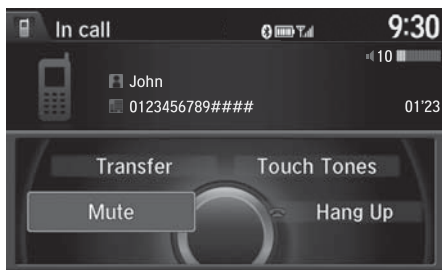
The available options are shown on the Phone screen.



Rotate  to select the option. Press .

► The mute icon appears when **Mute** is selected. Select **Mute** again to turn it off.

The following options are available during a call:

- **Mute:** Mute your voice.
- **Transfer:** Transfer a call from HFL to your phone.
- **Touch Tones:** Send numbers during a call. This is useful when you call a menu-driven phone system.

▣ Options During a Call

Touch Tones: Available on some phones when the vehicle is stopped.

Setting a Text Message/E-mail

To turn on or off the text/E-mail function

SETTINGS button ► Phone Settings ► Enable Text/Email

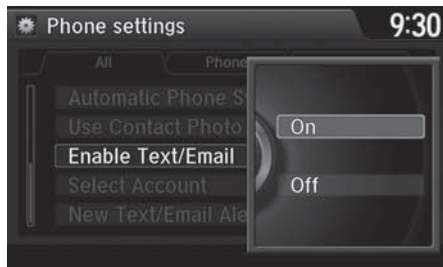

Rotate  to select On or Off. Press .

To turn on or off the text/E-mail notice

SETTINGS button ► Phone Settings ► New Text/Email Alert



Rotate  to select On or Off. Press .

The following items are available:

- **On:** A pop-up notification comes on every time you receive a new text message.
- **Off:** The message you receive is stored in the system without notification.

■ To set up the auto reading option

🔗 SETTINGS button ▶ System Settings ▶ **Message Auto Reading**

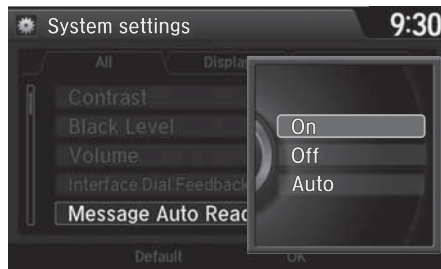

Rotate  to select **On**, **Off** or **Auto**.
Press .

The following items are available:

- **On**: A text message/Email is always read aloud.
- **Off**: A text message/Email is not read aloud.
- **Auto**: A text message/Email is read aloud only when driving.

Selecting a Mail Account

🔗 SETTINGS button ▶ **Phone Settings** ▶ **Select Account**

If a paired phone has text message or mail accounts, you can select one of them to be active and receive notifications.

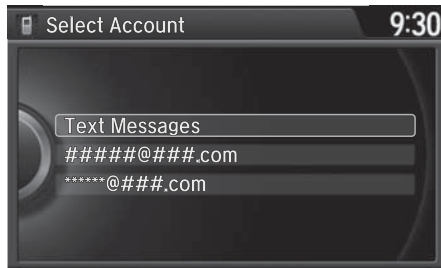

Rotate 📶 to **Text Messages** or an E-mail account you want. Press 📶.

📧 Selecting a Mail Account

You can also select a mail account from the folder list screen or the message list screen. Move 📶 to select **Select Account**, then press 📶.





You can only receive notifications from one text message or mail account at a time.

Receiving a Text Message/E-mail

HFL can display newly received text messages and E-mails as well as 20 of the most recently received messages on a linked cell phone. Each received message can be read aloud and replied to using a fixed common phrase.



1. A pop-up appears and notifies you of a new text message or E-mail.

2. Rotate  to select **Read** to listen to the message. Press .

▶ The text message or E-mail is displayed. The system automatically starts reading out the message.

3. To discontinue the message read-out. Press .

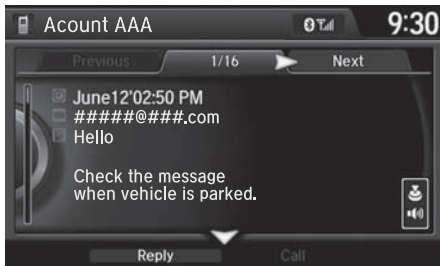

▶ Receiving a Text Message/E-mail

The system does not display any received messages while you are driving. You can only hear them read aloud.

With some phones, you may be able to display up to 20 most recent text messages and E-mails.

State or local laws may limit your use of the HFL text message/E-mail feature. Only use the text message/ E-mail feature when conditions allow you to do so safely.

When you receive a text message or E-mail for the first time since the phone is paired to HFL, you are asked to turn the **New Text/Email Alert** setting to On.

▶ **To turn on or off the text/E-mail notice**
P. 233

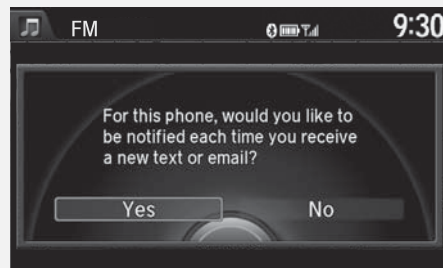

Displaying Messages

■ Displaying text messages

📞 MENU button (on Phone Settings) ▶ **Text/Email**

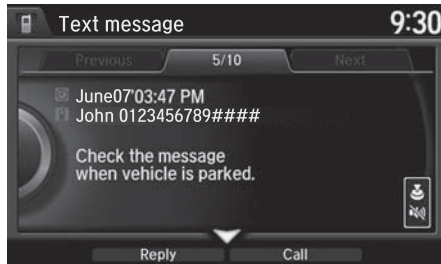
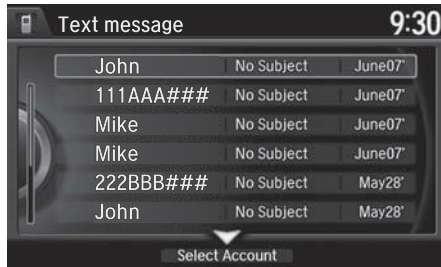

1. Select account if necessary.
2. Rotate 📶 to select a message. Press 🕒.
 - ▶ The text message is displayed. The system automatically starts reading the message aloud.

▶▶ Displaying Messages

The icon appears next to an unread message.



If you delete a message on the phone, the message is also deleted in the system. If you send a message from the system, the message goes to your phone's outbox.

To see the previous or next message, move ◀○ or ○▶ on the text message screen.



■ Displaying E-mails

📁 MENU button (on Phone Settings) ▶ **Text/Email**

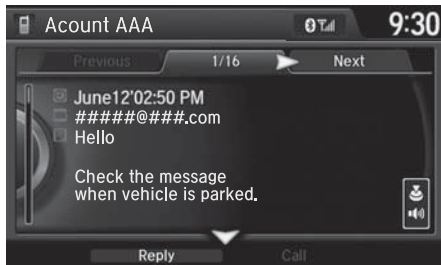

1. Rotate  to select a folder. Press .



2. Rotate  to select a message. Press .



▶ The text message is displayed.
The system automatically starts reading the message aloud.

☒ Displaying E-mails

Received text messages and E-mails may appear in the message list screen at the same time. In this case, text messages are titled **No subject**.

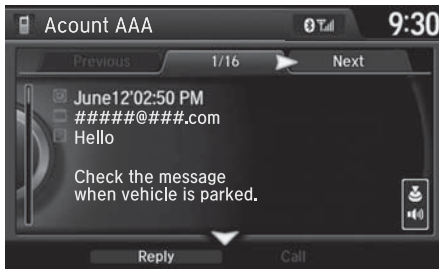

Read or stop reading a message



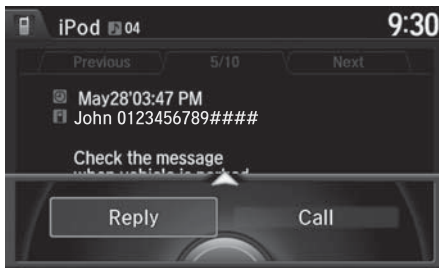

1. Go to the text message or E-mail screen.
 - ▶ The system automatically starts reading the message aloud.
 - ▶ **Displaying Messages P. 237**
2. Press  to stop reading. Press  again to start reading the message from the beginning.

Reply a message

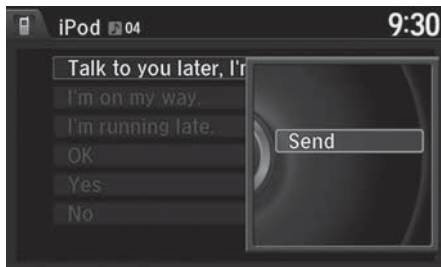

1. Go to the text message or E-mail screen.
 - ▶ The system automatically starts reading the message aloud.
 - ▶ **Displaying Messages P. 237**
2. Move  and rotate  to select Reply. Press .



3. Rotate  to select the reply message. Press .

▶ The pop-up menu appears on the screen.

4. Select **Send** to send the message.

▶ **Message Sent** appears on the screen when the reply message was successfully sent.

✉ Reply to a message

The available fixed reply messages are as follows:

- Talk to you later, I'm driving.
- I'm on my way.
- I'm running late.
- OK
- Yes
- No

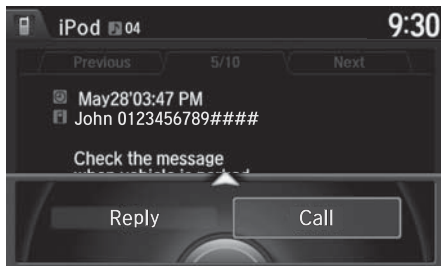

You cannot add, edit, or delete reply messages.

■ Making a call to a sender



1. Go to the text message screen. The system automatically starts reading the message aloud.

✉ **Displaying text messages** P. 237

2. Move  and rotate  to select **Call**. Press .

HFL Menus

The power mode must be in ACCESSORY or ON to use HFL.

■ Phone Settings screen



1. Press the SETTINGS button.
2. Rotate to select **Phone Settings**, then press .

» HFL Menus

To use HFL, you must first pair your *Bluetooth*®-compatible cell phone to the system while the vehicle is parked.

Some functions are limited while driving. A message appears on the screen when the vehicle is moving and the operation is canceled.

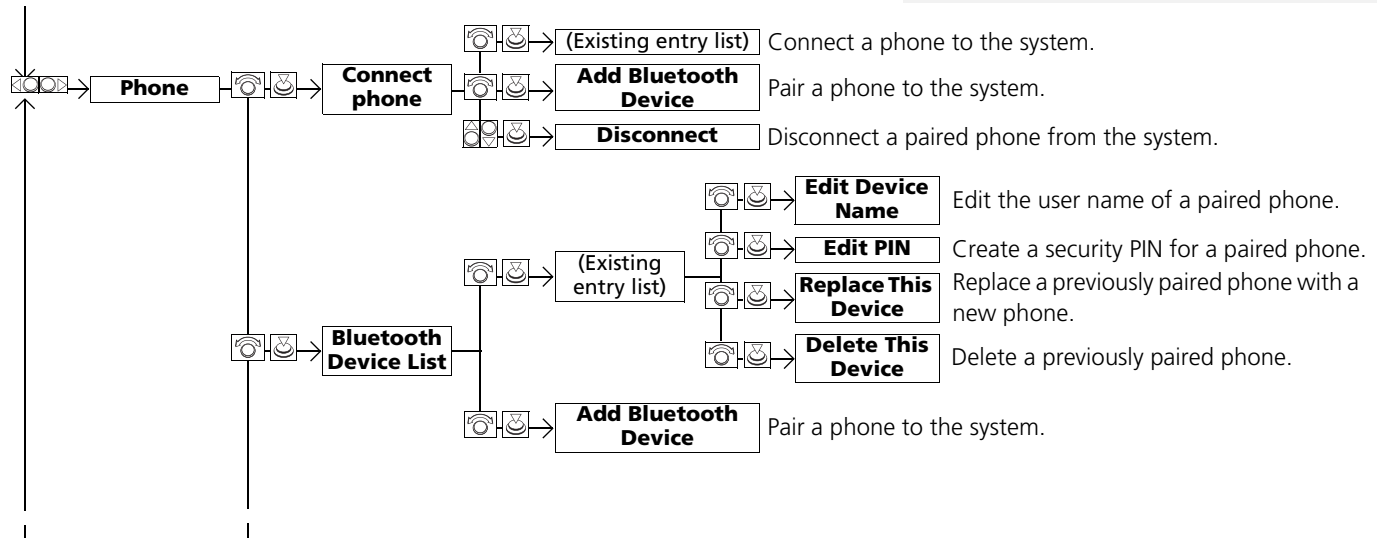

*1: Appears only when a phone is connected to HFL.

Bluetooth® HandsFreeLink®

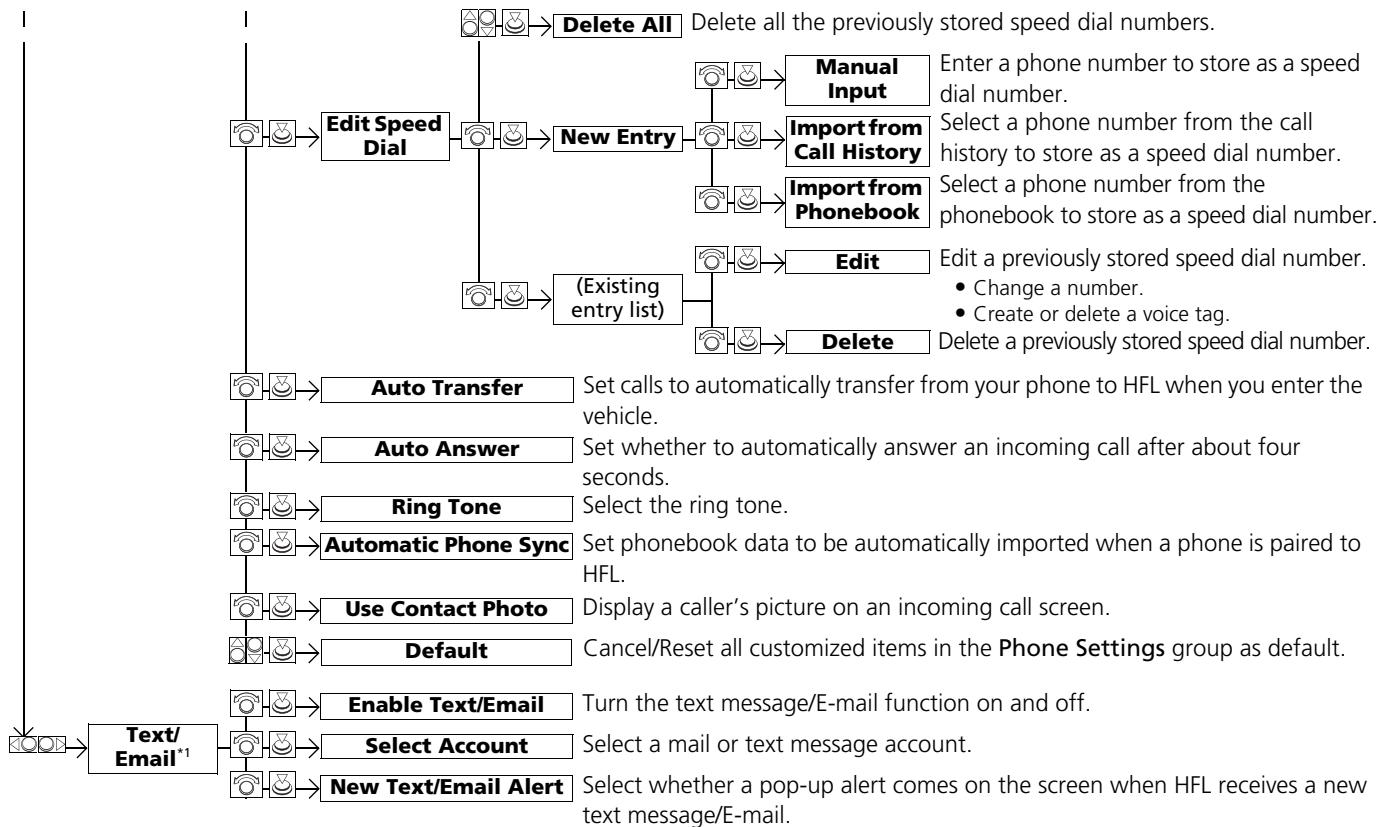

*1: Appears only when a phone is connected to HFL.

■ Phone screen



1. Press the PHONE button.
2. Press the MENU button to display the menu items.

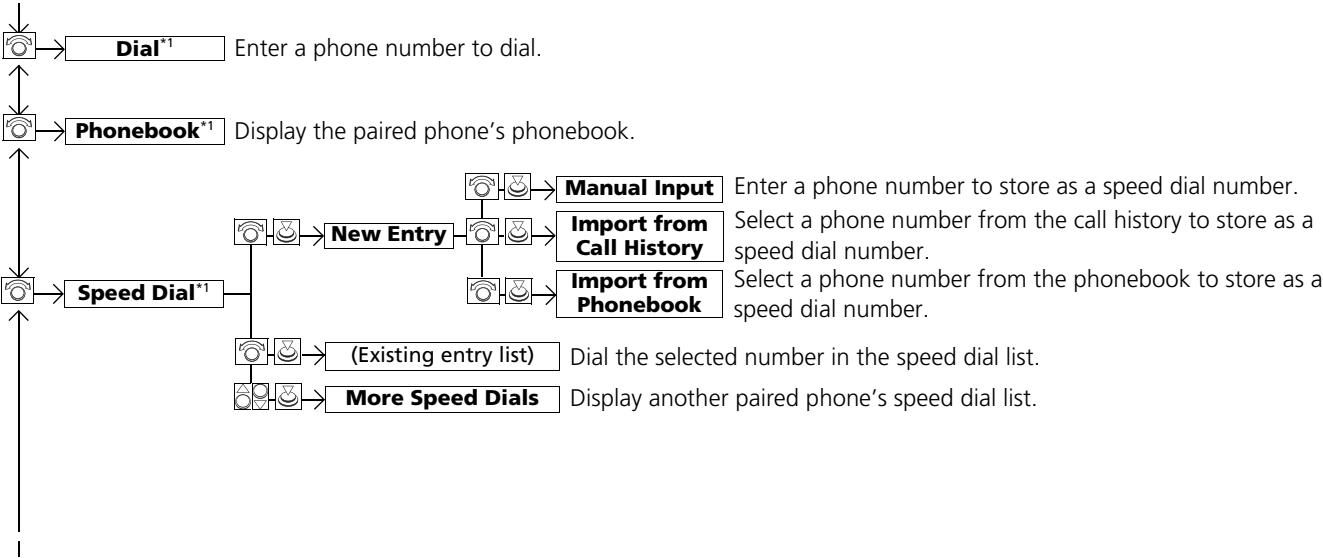

*1: Appears only when a phone is connected to HFL.

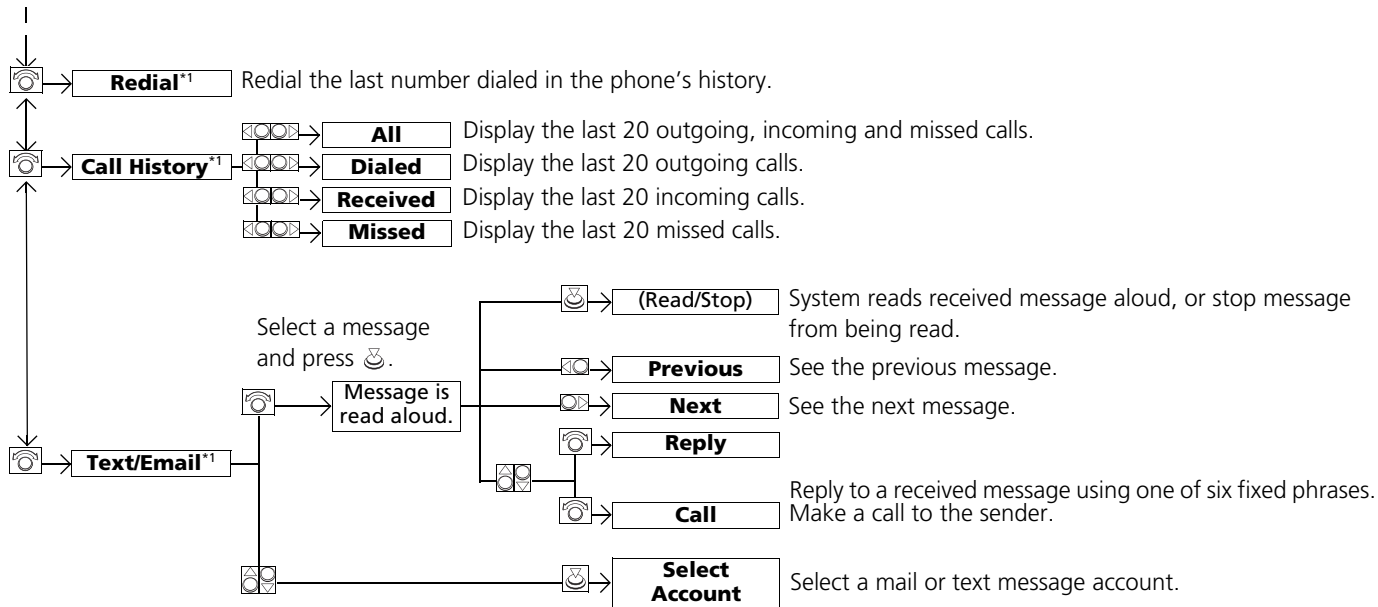

*1: Appears only when a phone is connected to HFL.

Rear Entertainment System

Rear seat passengers can enjoy a completely separate entertainment source than front passengers, including movies, games, and other audio choices.

Rear Entertainment System	246
Auxiliary Console Panel	246
HDMI Input Jack (Ultrawide RES only).....	247
Rear Control Panel Operation	250
Selecting the Audio Source	250
Rear DVD Menu	251
Screen and Surround Settings	254
DVD Initial Settings (RES only)	257
Dual Screen Mode (Ultrawide RES only).....	258
Replacing the Batteries.....	260
Front Control Panel Operation	261
Selecting the Audio Source using front control panel.....	261
Rear System Setup	262
Setting the DVD Menu	263
Wireless Headphones	265
Using the Wireless Headphones	265
Changing the Sound Source (Ultrawide RES only).....	266
Replacing the Batteries	267

The Rear Entertainment System (RES) is operable from both the front control panel and the rear control panel.

➤ **Front Control Panel Operation** P. 261

➤ **Rear Control Panel Operation** P. 250

Auxiliary Console Panel

Auxiliary input jacks and headphone connectors for the rear entertainment system are above the third row seat armrest on the driver's side.

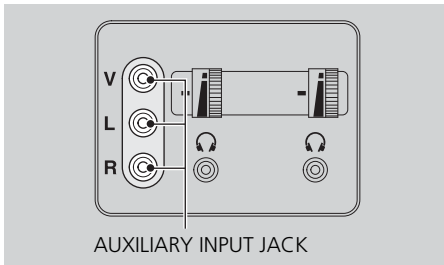

V = Video jack

L = Left audio jack

R = Right audio jack

■ Auxiliary Input Jacks

The system will accept auxiliary inputs from standard video games and video equipment. Some video game power supplies may cause poor picture quality.

■ Headphone Connectors

There are two headphone connectors for the rear passengers. Each connector has its own volume control.

➤ Rear Entertainment System

NOTICE

This vehicle's overhead mounted video display, if so equipped, includes mercury-containing components. Upon removal, please reuse, recycle, or dispose of as hazardous waste.

HDMI Input Jack (Ultrawide RES only)

There is an HDMI input jack above the third row seat armrest on the passenger's side. The system will accept HDMI input from video games and video equipment which are equipped with an HDMI jack.

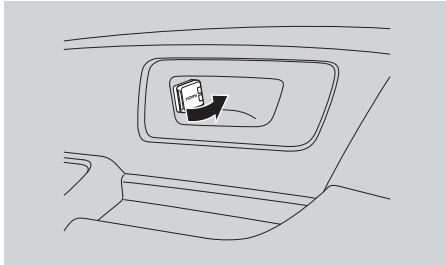

Open the outlet cover and insert the cable.

Audio Sources for Front and Rear Seats

The table shows the possible audio source combinations of the front audio system and rear entertainment system's simultaneous use.

Front Rear	AM/FM Radio	XM® Radio	CD	DVD*1	HDD	USB iPod®	Bluetooth® Audio	Pandora® Aha™
AM/FM Radio	Yes	Yes	Yes	Yes	Yes	Yes	Yes	Yes
XM® Radio	Yes	Yes	Yes	Yes	Yes	Yes	No	No
CD	Yes	Yes	Yes	Yes	Yes	Yes	Yes	Yes
DVD	Yes	Yes	Yes	Yes	Yes	Yes	Yes	Yes
HDD	Yes	Yes	Yes	Yes	Yes	Yes	Yes	Yes
USB iPod®	Yes	Yes	Yes	Yes	Yes	Yes	Yes	Yes

*1. The front seat passengers are only able to hear the DVD's sound from the front speakers.

▣ Audio Sources for Front and Rear Seats

Yes: These audio sources are simultaneously playable. When listening to same source in both the front and rear, the playing channel or track will also be the same for each.

No: These audio sources are not simultaneously playable.

Playable Discs

The discs that come with these labels can be played in your vehicle's rear entertainment system.

Also look for the region code of 1 or ALL on the package or jacket on the disc.

DVD-ROMs are not playable in this unit.

The disc packages or jackets should have one of these marks.



Also includes:



▶ Playable Discs

This product incorporates copyright protection technology that is protected by U.S. patents and other intellectual property rights.

Use of this copyright protection technology must be authorized by Rovi Corporation, and is intended for home and other limited viewing uses only unless otherwise authorized by Rovi Corporation. Reverse engineering and disassembly are prohibited.

Manufactured under license under U.S. Patent Nos: 5,956,674; 5,974,380; 6,487,535 & other U.S. and worldwide patents issued & pending. DTS, the Symbol, & DTS and the Symbol together are registered trademarks & DTS Digital Surround and the DTS logos are trademarks of DTS, Inc. Product includes software. © DTS, Inc. All Rights Reserved.

Manufactured under license from DTS Licensing Limited. DTS, the Symbol, & DTS and the Symbol together are registered trademarks & DTS Neural Surround is a trademark of DTS, Inc. Product includes software. © DTS, Inc. All Rights Reserved.

Manufactured under license from Dolby Laboratories. Dolby, Pro Logic, MLP Lossless and the double-D symbol are trademarks of Dolby Laboratories.

Selecting the Audio Source

■ RES

1. Press the Rear Power button on the front control panel.
2. Press the audio source button on the rear control panel.
 - ▶ You can also change the audio source by the front control panel.
 - **Selecting the Audio Source using front control panel** P. 261
3. Select a station, channel, track, or chapter using the CH/FOLDER, TUNE/SKIP, or CATEGORY bars.
 - **Overhead Screen and Rear Control Panel** P. 14

■ Ultrawide RES



1. Press the Rear Power button on the front control panel.
2. Press the SOURCE button on the rear control panel.
 - ▶ You can also change the audio source by the front control panel.
 - **Selecting the Audio Source using front control panel** P. 261
4. Select a station, channel, track, or chapter using the CH/FOLDER, TUNE/SKIP, or CATEGORY bars.

➤ Rear Control Panel Operation

In the procedures of this section, “select” means the following actions:

RES

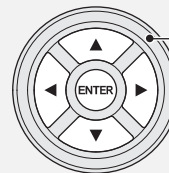

Press the cursor buttons on the rear control panel.

Ultrawide RES

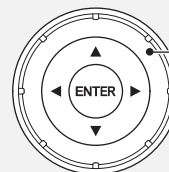

Rotate the Interface Dial on the rear control panel.

The rear control panel can be detached from the ceiling unit and used as a remote control.

➤ **Overhead Screen and Rear Control Panel** P. 14

In this section, screen illustrations from the standard RES are used for the explanation unless otherwise noted.

The screen is displayed on the overhead screen.



Rear DVD Menu

 MENU button (in the DVD mode)



Select an item. Press the ENTER button.

The following items are available:

- **Top Menu:** Displays the top menu of the DVD.
- **Menu:** Displays the menu of the DVD.
- **Play Mode:** Displays while a DVD is playing and changes the DVD's audio, subtitle, or angle settings.
 - ▶ **Setting the Play Mode** P. 252
- **Initial Settings:** Displays while a DVD is not playing and changes the DVD preferences.
 - ▶ **DVD Initial Settings (RES only)** P. 257
- **Search/NumInput:** Skips to a title or chapter by entering the number.
 - ▶ **Searching a Title/Chapter** P. 253
- **Repeat:**
 -  TITLE REPEAT: Repeats the current title.
 -  CHAPTER REPEAT: Repeats the current chapter.
- **Pause/Play:** Pauses or resume the playback
- **Stop:** Stops the playback.
- **Return:** Hides the rear audio menu.

■ Setting the Play Mode

🔑 MENU button (in the DVD mode) ▶ **Play Mode**



1. Select an item. Press the ENTER button.
2. Select an option. Press the ENTER button.

The following items are available:

- **Audio:** Selects the language of the DVD audio.
- **Subtitle:** Selects the language of the DVD subtitle.
- **Angle:** Selects the angle of a scene shot with multiple cameras.

■ Searching a Title/Chapter

🔍 MENU button (in the DVD mode) ▶ **Search/NumInput**



1. Select an item. Press the ENTER button.
2. Select a number. Press the ENTER button.

The following items are available:

- **Title:** Skips to a title you specify.
- **Chapter:** Skips to a chapter you specify.
- **NumInput:** Enters a number of a title or chapter to skip.

RES

Enter a number and select ENT. Press the ENTER button.

Ultrawide RES

Enter a number and press the ENTER button. Select DONE.

Screen and Surround Settings

🔑 SETUP button (in the DVD mode)



Select an item. Press the ENTER button.

The following items are available:

- **Brightness** (Ultrawide RES only): Adjusts the screen's brightness. Adjust the brightness using the Interface Dial and press the ENTER button.
- **Appearance** (Ultrawide RES only): Selects the color of the rear menu screen.
- **Display Adjust**: Adjusts the screen's preferences.
▶ **Adjusting the Screen** P. 255
- **Aspect Ratio**: Selects an aspect ratio of the image
▶ **Setting the RES Aspect Ratio** P. 256
▶ **Setting the Ultrawide RES Aspect Ratio** P. 256
- **PERSONAL SURROUND**: Sets the surround of the wireless headphones. You can choose from three options: **Music**, **Cinema**, or **Voice**. Select **Off** to disable the feature.
- **Language**: Sets the system language used on all screens. You can choose from three languages: **English**, **Français** (French), or **Español** (Spanish).

■ Adjusting the Screen

🔍 SETUP button (in the DVD mode) ▶ **Display Adjust**



1. Select an item. Press the ENTER button.
2. Make the adjustment. Press the ENTER button.

The following items are available:

- **Brightness** (RES only): Adjusts the screen's brightness.
- **Contrast**: Adjusts the screen's contrast.
- **Black Level**: Adjusts the screen's black level.
- **Color**: Adjusts the screen's color strength.
- **Tint**: Adjusts the screen's hue.
- **Reset**: Resets all the settings to their factory default.

■ Setting the RES Aspect Ratio

🔑 MENU button (in the DVD mode) ▶ **Aspect Ratio**

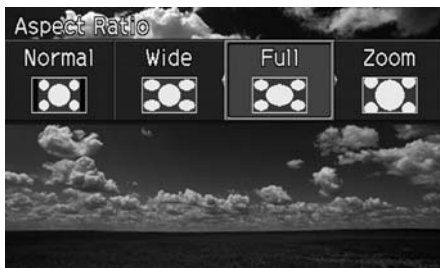

Select an option. Press the ENTER button.

■ Setting the Ultrawide RES Aspect Ratio

🔑 MENU button (in the DVD mode) ▶ **Aspect Ratio**



1. Select an item. Press the ENTER button.

2. Select an item. Press the ENTER button.

The following items are available:

- **Wide:** Selects the wide screen option (**Normal, Full, Super Full, Ultra Full**).
- **Zoom:** Selects the zoom screen option (**Super Zoom, Ultra Zoom**).

DVD Initial Settings (RES only)

 MENU button (in the DVD mode) ▶ **Initial Settings**

Set the DVD default settings so that you do not have to select the settings each time you play a DVD.



1. Select an item. Press the ENTER button.
2. Select an option. Press the ENTER button.

The following items are available:

- **Language Settings:** Selects a menu language of the DVD (top) menu.
 **Selecting the DVD Menu Language** P. 258
- **Dynamic Range:** Sets whether to control the range of the loud and low sounds.
On: Adjusts the dynamic range to easily hear the low sound.
Off (factory default): Disables the feature.
- **Angle Mark:** Sets whether to display the angle symbol.
On: Displays the angle symbol when playing the multiple angle scenes.
Off (factory default): Disables the feature.

■ Selecting the DVD Menu Language

🔑 MENU button (in the DVD mode) ▶ **Initial Settings** ▶ **Language Settings**

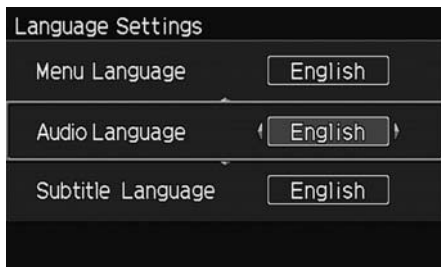

1. Select an item. Press the ENTER button.
2. Select a language. Press the ENTER button.

☒ Selecting the DVD Menu Language

When you select **Other**, enter a 4-digit language code.

☒ **List of Language Codes** P. 321

Dual Screen Mode (Ultrawide RES only)

Select between the two screen modes, single or dual.

■ Single Mode

The selected source is displayed in the center of the screen.

■ Dual Mode

Two separate screens are displayed side by side. You can only select one output source from the front audio system. The other source must come from "AUX-VIDEO" or "AUX-HDMI."

■ Single mode to Dual mode

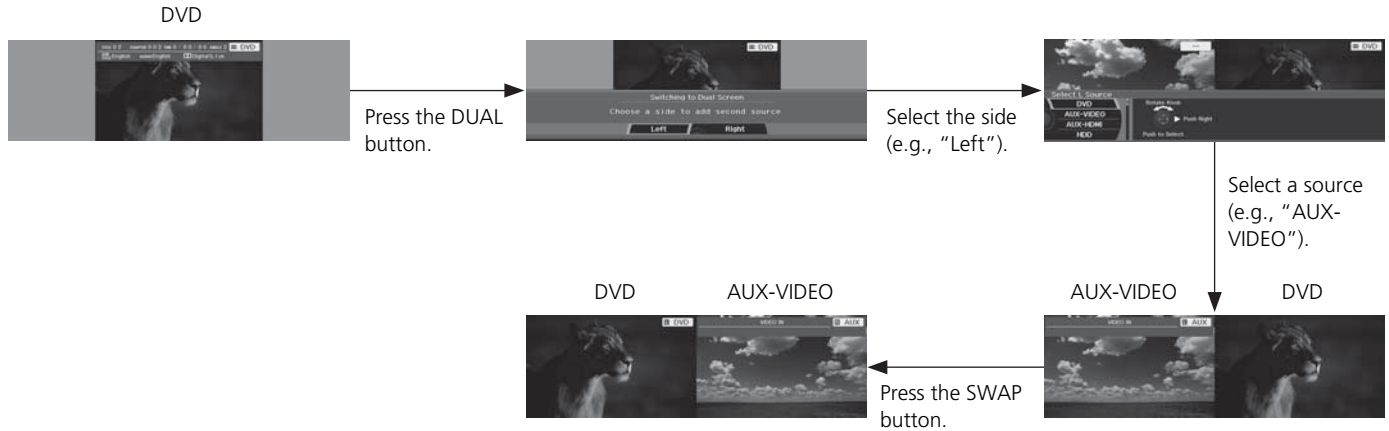

■ Dual mode to Single mode



Replacing the Batteries

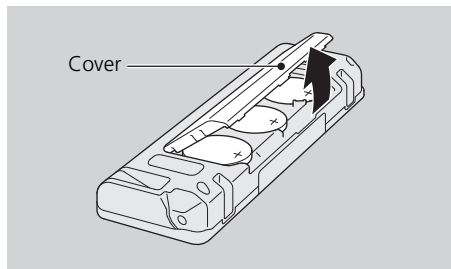

1. Remove the rear control panel.
▶ **Overhead Screen and Rear Control Panel** P. 14
2. Open the cover.
3. Change the batteries.
▶ Battery type: BR3032

▶▶ Replacing the Batteries

An improperly disposed of battery can hurt the environment. Always confirm local regulations for battery disposal.

Operate the Rear Entertainment System (RES) from the front control panel.

Selecting the Audio Source using front control panel







1. Press the Rear  (Power) button on the front control panel.
2. Press the REAR AUDIO button.
 - ▶ The rear source is displayed on the front audio screen and the touchscreen.
 - ▶ The rear source is heard from the front speakers.
3. Select **Rear Audio Source** on the touchscreen.
4. Select the audio source icon on the touchscreen.
5. Select a station, channel, track, or chapter in the same way as the front audio system.
➤ **Audio P. 135**

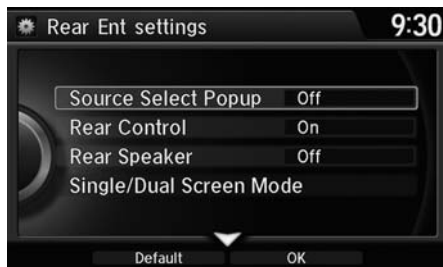

Rear System Setup

🔑 SETTINGS button ▶ Rear Ent Settings



1. Rotate  to select an item. Press .
2. Rotate  to select an option. Press .

The following items are available:



- **Source Select Popup:** Selects whether the list of selectable audio sources comes on when the AUDIO button is pressed.
- **Rear Control:** Sets whether to use the rear control panel to control the RES.
On (factory default): Operates the RES using the rear control panel.
Off: Disables the feature.
- **Rear Speaker:** Sets the front audio source to play through the rear speakers, even when the RES is on. The RES source can only be heard through the wireless headphones.
On (factory default): Outputs the sound of the front source to the rear speakers.
Off: Disables the feature.
- **Single/Dual Screen Mode** (Ultrawide RES only): Selects a source to continue playing when you switch from dual mode to single mode on the overhead screen. Rotate  to select a source and press .

Setting the DVD Menu



Interface Dial

 MENU button (in DVD mode)



1. Rotate  to select an item. Press .
▶ Select **Other Function** to display additional menu entries.



2. Rotate  to select an option. Press .

The following items are available:

- **Top Menu:** Displays the top menu of the DVD.
- **Menu:** Displays the menu of the DVD.
- **Repeat:**
Repeat Title: Repeats the current title.
Repeat Chapter: Repeats the current chapter.
- **Change Source:** Changes the audio source mode.

- **Play/Pause:** Pauses or resume the playback.
- **Stop:** Stops the playback.
- **Audio/Subtitle:** Selects the language of the DVD audio and the DVD subtitle.
- **Angle:** Selects the angle of a scene shot with multiple cameras.
- **Return:** Hides the DVD menu.
- **Number Input:** Enters a number of a title or chapter to skip.
- **Search:** Skips to a title or chapter by Interface Dial.

Touchscreen



1. Select **More**.
2. Select a setting item.

The following items are available:

- **Sound Settings:** Displays the sound preferences screen.
 - ▶ **Adjusting the Sound** P. 145
- **Stop:** Stops the playback.
- **Repeat:**
 - Repeat Title: Repeats the current title.
 - Repeat Chapter: Repeats the current chapter.
- **Screen Settings:** Displays the screen preferences screen.
 - ▶ **Changing the Screen Settings** P. 82

Using the Wireless Headphones

Audio for the Rear Entertainment System is sent to the wireless headphones that come with the system.

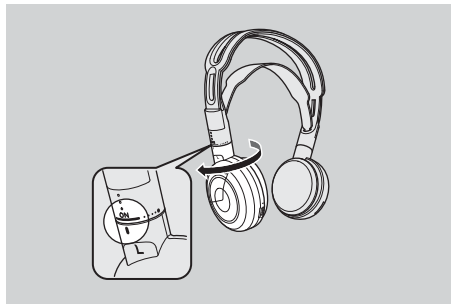

1. Pivot the earpieces outward.



2. Adjust the volume by turning the dial on the bottom of the right earpiece.

3. Wear the headphones correctly with the left and right earpieces on the correct sides.

▶ L (left) and R (right) are marked on the sides of the frame.

Using the Wireless Headphones

When you remove the headphones, the earpieces automatically pivot inward, and the headphones turn off. When not in use, store the headphones in the back pocket of either front seat.

You can use wired headphones through the auxiliary input jacks.

▶ **Auxiliary Console Panel** P. 246

Changing the Sound Source (Ultrawide RES only)

■ Wireless Headphone

In dual screen mode, you can switch the sound source of the wireless headphones between the left and right side screens.

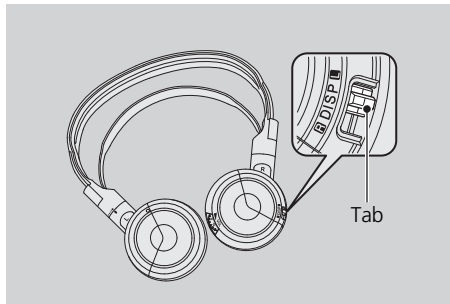

Slide the tab to "L" for the left side, or "R" for the right side.

☒ Changing the Sound Source (Ultrawide RES only)

You can switch the sound source from the setup menu if you connected a set of wired headphones.

1. Press the **SETUP** button on the rear control panel.
2. Select **Wired Headphones**. Press the **ENTER** button.
3. Select **Left** or **Right** to switch the sound source. Press the **ENTER** button.

Replacing the Batteries

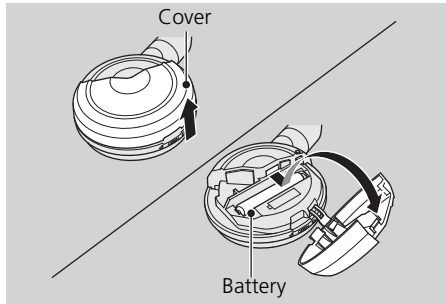
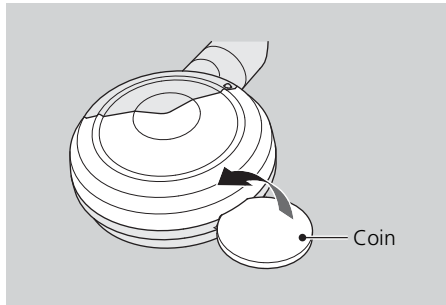

1. Insert a coin in the slot and twist it slightly to pry the cover away from the earpiece.
2. Pull the cover outward, and pivot it out of the way.
3. Remove the battery.
4. Install the new battery in the earpiece as shown in the diagram next to the battery slot.
 - ▶ Battery Type: AAA battery
5. Slide the cover back into place on the earpiece, then press down on the back edge to lock it in place.

✕ Replacing the Batteries

The battery is under the cover on the left earpiece.

An improperly disposed of battery can hurt the environment. Always confirm local regulations for battery disposal.

If static is heard in the headphones, try replacing the battery.

Other Features

This section describes the useful functions incorporated into the navigation system to help make your journey easier and more enjoyable.

Trip Computer	270
Calendar	271
Information Functions	272
System Device Information	272
Map Data Update	272
Info Screen Preference	273
Multi-view Rear Camera	274
About Your Multi-View Rear Camera ...	274

INFO button ► Trip Computer

View the distance traveled and average fuel consumption.

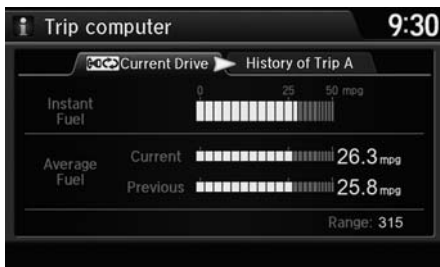

Move ◀○ or ○▶ to select the trip information.

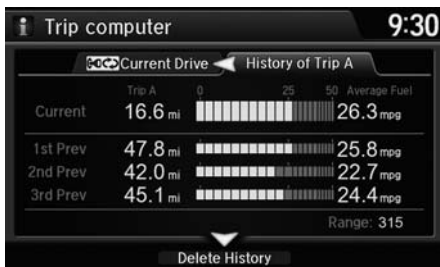

The following items are available:

- **Current Drive:** Displays the current trip information.
- **History of Trip A:** Displays information for three previous histories. The information is stored every time you reset Trip A.
- **Delete History:** Deletes the trip information. Move ◊ on the Trip A screen to select **Delete History**, then press ◊. You will receive a confirmation message on the screen. Rotate ◊ to select **Yes**, then press ◊.

▣ Trip Computer

Displays the following trip information:

- **Instant Fuel:** The current estimated instant fuel economy.
- **Average Fuel:** The average fuel economy since the last key cycle.
- **1st, 2nd, 3rd Prev.:** The previous average fuel consumption.
- **Range:** The estimated distance you can travel on the fuel remaining in the tank.

These values are estimates only.

🔔 INFO button ► **Calendar**

View the calendar screen.



Move ◀○ or ○▶ to select the months of the year.

System Device Information

SETTINGS button ► Navi Settings ► Map ► System Device Information

View database, software, device, and vehicle identification information.



Map Data Update

SETTINGS button ► Navi Settings ► Map ► Map Data Update

Check the map data update status when updating the map database.

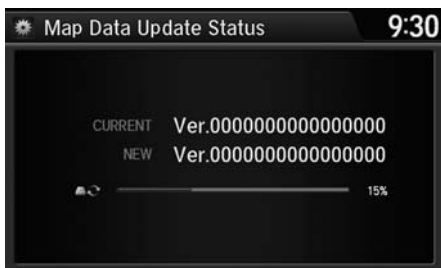

System Device Information

You will need this information when ordering a map update.

► Obtaining a Navigation Update P. 297

Map Update Status

This operation is only available during a database update.

► Obtaining a Navigation Update P. 297

Info Screen Preference

🔧 SETTINGS button ▶ **Info Settings** ▶ **Other** ▶ **Info Screen Preference**

Select the top menu when the INFO button is pressed.



Rotate 🔄 to select your desired setting item. Press ⏏.

The following options are available:

- **Info Top**: A brief menu pops up.
- **Info Menu** (factory default): A full menu pops up.
- **Off**: A menu does not pop up.

About Your Multi-View Rear Camera

The navigation screen can display your vehicle's rear view. The display automatically changes to the rear view when the shift lever is moved to Reverse.

Multi-View Rear Camera Display Area

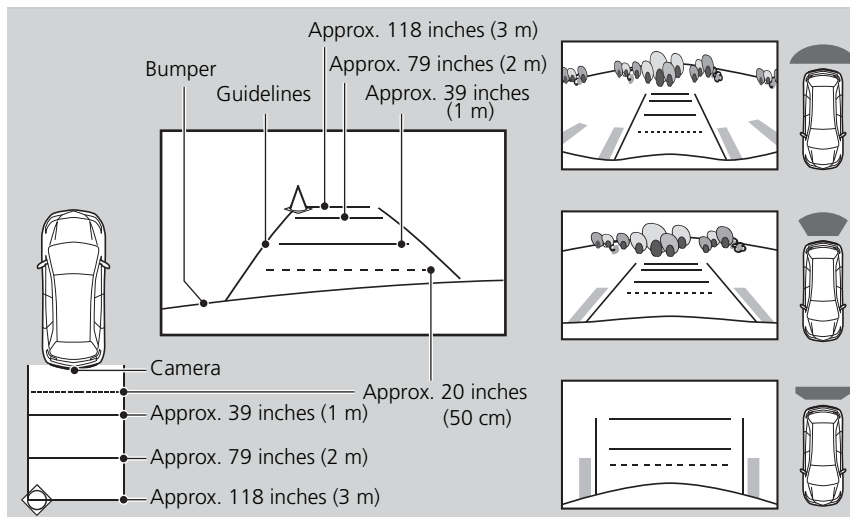

You can view three different camera angles on the rearview display. Press the interface dial to switch the angle.

If Top View is last used before you turn the power mode to OFF, Wide mode is selected next time you turn the power on and move the shift lever to Reverse.

⊗ About Your Multi-View Rear Camera

The rear camera view is restricted. You cannot see the corner ends of the bumper or what is underneath the bumper. Its unique lens also makes objects appear closer or farther than they actually are.



Visually confirm that it is safe to drive before backing up. Certain conditions (such as weather, lighting, and high temperatures) may also restrict the rear view. Do not rely on the rearview display which does not give you all information about conditions at the back of your vehicle.

If the camera lens is covered with dirt or moisture, use a soft, moist cloth to keep the lens clean and free of debris.

Multi-View Rear Camera Settings

SETTINGS button ▶ **Camera Settings** ▶ **Fixed Guideline**



Rotate  to select an item. Press .

The following items are available:





- **On** (factory default): Guidelines appear when you shift into Reverse.
- **Off**: Guidelines do not appear when the dynamic guideline is off.





Troubleshooting



Troubleshooting	278
Map, Voice, Entering Destinations	278
Traffic	280
Guidance, Routing	281
Update, Coverage, Map Errors	283
Display, Accessories	283
Miscellaneous Questions	283
Error Messages	284
Navigation System	284
CD Player	285
Hard Disc Drive (HDD) Audio	286
iPod®/USB Flash Drive	287
Pandora®	288
Aha™ Radio	289

Map, Voice, Entering Destinations







Problem	Solution
The Startup Confirmation screen is displayed every time I start the car.	This is normal. The Startup Confirmation screen reminds you and your guest drivers to always operate the navigation system in a safe manner. The Startup Confirmation screen goes off after a certain period of time and the top screen of the last mode is displayed.
The navigation system reboots by itself (returns to the opening screen).	A reboot can be caused by extreme temperatures or shock from bumpy roads, and does not necessarily indicate a problem. If this happens frequently, please see a dealer.
How do I specify a destination when an entered city or street could not be found?	<ul style="list-style-type: none"> • Try entering the street first. Some cities are lumped in with a major metro area. In rural “unverified” areas or new subdivisions, streets may be missing or only partially numbered. • Try selecting the destination directly from the map. <p> Map Input P. 105</p>
Why do some letters become grayed out when I enter an address?	As you enter each letter in an address or a place/landmark, the navigation system looks in the database to see what letters are possible and grays out letters that do not apply.
How do I delete Personal Addresses, Previous Destinations, or the Home Address?	<ol style="list-style-type: none"> 1. Press the SETTINGS button. Select Navi Settings > Personal Info to display the types of information. 2. Select the type of address to delete. 3. Select Delete.
I cannot hear the navigation system voice.	<ol style="list-style-type: none"> 1. Press the SETTINGS button. Select System Settings and check that Volume is not set to 0. 2. Select Voice Rec. and set Voice Prompt to On.
The voice control system is having difficulty recognizing my voice commands.	<ul style="list-style-type: none"> • Check that the vents are not blowing air onto the microphone on the ceiling, the vehicle is as quiet as possible, and you are using the correct command when speaking. <p> Voice Recognition P. 23</p> <ul style="list-style-type: none"> • Say  “Voice Help” on any screen to see a list of the applicable voice commands.
I cannot give voice commands.	<p>Make sure you selected OK at the Startup Confirmation screen.</p> <p> Start-up P. 20</p>

Problem	Solution
I cannot select an option using the Interface Dial.	To reduce potential driver distraction, certain onscreen functions and features are limited or inoperable while the vehicle is moving. Use voice commands or pull over to proceed.
The navigation system pronunciation of street names in the guidance command or destination address sounds strange.	The basic guidance phrases use a studio-recorded voice, but street names are pronounced using a machine-generated voice. Consequently, the name may be mispronounced or sound strange at times.
The screen is bright when I drive at night.	<ol style="list-style-type: none"> 1. Check that the nighttime dashboard brightness control is not set to maximum. 2. Press the SETTINGS button. Select Navi Settings > Map > Color (Night). Set the Night color to Black for the best contrast.  Switching Display Mode Manually P. 70
The screen is dark when I drive during the day.	<p>Press the SETTINGS button. Select Navi Settings > Map > Color (Day). Set the Day color to White for the best contrast.</p> <p> Switching Display Mode Manually P. 70</p>
How do I change or remove my PIN?	<ol style="list-style-type: none"> 1. Press the SETTINGS button. Select Navi Settings > Personal Info > PIN Number > Address Book PIN or Go Home PIN. 2. Enter your existing PIN. You then have the choice to change or remove the PIN.  PIN Numbers P. 43
I have forgotten my PIN. How do I reset the PIN for Home or the PIN for personal addresses?	A dealer must reset the PIN for you.
Why is Call grayed out on the Calculate Route screen?	<p>Your phone is not paired to Bluetooth® HandsFreeLink® or, if paired, your phone is in use.</p> <p> Bluetooth® HandsFreeLink® P. 204</p>

Traffic



Problem	Solution
<p>My FM Traffic is missing or is not displaying properly. What is wrong?</p>	<p>Verify the following:</p> <ul style="list-style-type: none"> • FM Traffic relies on a clear FM signal. If signal strength is low, traffic data may not be available. • Check the traffic icons and traffic flow on the Navi Settings. <ul style="list-style-type: none"> ▶ Showing Icons on Map P. 67 • It is possible that there is a temporary technical problem with your metropolitan area traffic. <ul style="list-style-type: none"> You can call Honda Automobile Customer Service to see if there is an outage. ▶ Honda Automobile Customer Service Contact Information P. 296 • If the situation persists, see your Honda dealer for assistance.
<p>The navigation system sometimes provides a detour route when I am driving a route on the freeway.</p>	<p>If Traffic Rerouting is set to On, the navigation system provides a detour route to your destination only if it can find a significantly faster route than the original one.</p> <p>▶ Traffic Rerouting P. 53</p>
<p>The navigation system routes me to an exit and an alternate freeway with unknown flow speeds or surface streets.</p>	<p>The navigation system predicts which route should be faster based on freeway congestion along your route. Use your own experience to determine whether the alternate route would be faster.</p>
<p>How can I ignore the detour route and return to the original route?</p>	<p>Press the SETTINGS button. Select Navi Settings > Routing, and set Traffic Rerouting to Off.</p> <p>▶ Traffic Rerouting P. 53</p>

Guidance, Routing

Problem	Solution
The navigation system does not route me the same way I would go or the same way as other mapping systems.	The navigation system attempts to generate the optimal route. You can change the route preferences used when calculating a route.  Route Preference P. 50
The navigation system wants to route me around potential traffic problems. How do I stop these pop-up messages?	Press the SETTINGS button. Select Navi Settings > Routing , and set Traffic Rerouting to Off .  Traffic Rerouting P. 53
The street I'm on is not shown on the map screen.	The mapping database is constantly undergoing revision. You can access the most recent information on the internet.  Map Coverage P. 297
The vehicle position icon is not following the road and the "GPS icon" text in the upper left hand corner of the screen is white or missing.	<ul style="list-style-type: none"> • Check that the GPS antenna (located in the dashboard) is not blocked. For best reception, remove items from the dashboard, such as radar detectors, cell phones, or loose articles. • Metallic tinting or other aftermarket devices can interfere with the GPS reception. Please consult a dealer.  GPS System P. 294
The blue highlighted route and voice guidance stopped or turned into a blue/pink line before I got to my destination.	Your route has entered an unverified area.  Unverified Routing P. 51
How do I stop the map from rotating as I drive along?	Press the SETTINGS button. Select Navi Settings > Map > View > North-Up , or say  "Display north-up" to change the map orientation.
The "time to destination" display sometimes increases even though I am getting closer to my destination.	If your speed reduces due to slower traffic, the navigation system updates the "time to destination" based on your actual road speed to give you a better estimate of arrival time.
The vehicle position icon on the map "lags" a short distance behind, especially when I arrive at an intersection.	This is normal. The navigation system is unaware of the width of intersections. Large differences in vehicle position can indicate a temporary loss of the GPS signal.  GPS System P. 294

Problem	Solution
The screen is showing white dots as I drive along.	These dots are called “breadcrumbs.” These are displayed if Display Tracking is set to On . ▶ Display Tracking P. 79
How do I remove the white dots (“breadcrumbs”) from my screen?	Press the SETTINGS button. Select Navi Settings > Map , set Display Tracking to Off or select Delete Tracking to remove the white dots from the map. ▶ Display Tracking P. 79
A road that I selected to avoid is being used when routing.	When you “draw” your area to avoid, make sure to select sections of roads that include at least one intersection. ▶ Avoided Area P. 55
My elevation (shown when I display the current position) seems to fluctuate even though my elevation has not changed.	This is normal. The elevation can vary ± 100 feet due to GPS calculation errors. ▶ GPS System P. 294
My elevation is missing on the “current position” screen.	The elevation is only displayed if the GPS antenna can receive signals from at least four satellites. Try moving the vehicle into an open area. The elevation is also not displayed if the calculated elevation is zero or below sea level.

Update, Coverage, Map Errors

Problem	Solution
My city is not part of a fully verified detailed coverage area.	The mapping database is constantly undergoing revision. You can access the most recent information on the internet.  Map Coverage P. 297
Does the navigation system work outside North America?	The navigation system contains maps for the 50 U.S. states, Canada, Puerto Rico, and Mexico. The navigation system will not work in other countries.  Map Coverage P. 297
How do I report errors I find in the database?	Minor errors are bound to occur in a large database. If you encounter major errors, see  Reporting Errors P. 296

Display, Accessories

Problem	Solution
The display appears dim when starting the car in really cold weather.	This is normal. The display will become brighter after a few minutes.

Miscellaneous Questions





Problem	Solution
My battery was disconnected or went dead, and the navigation system is asking for a code.	Set the power mode to ON, and press and hold the  (Power) button for two seconds. The system should reactivate. If you have installed an aftermarket system, contact a dealer.

Navigation System

Error Message	Solution
The display temperature is too high. For protection, the system will shut off until the display cools down.	This message appears briefly when the display temperature is too high. The navigation system turns off until the display cools down. The system turns back on automatically when the display cools down.
System temp is low. System will shut down until it warms up.	The navigation system has difficulty reading the HDD when the temperature is below approximately -22°F (-30°C). The navigation system starts up automatically when the display warms up.
The navigation system temperature is too low. For protection, the system will shut off until it warms up.	
The navigation system atmospheric pressure is too low. For protection, the system will shut off until the pressure returns to safe levels.	The HDD is inoperable due to low atmospheric pressure. Move your vehicle to the place where the atmospheric pressure is high.
The navigation system temperature is too high. For protection, the system will shut off until it cools down.	The navigation system has difficulty reading the HDD when the temperature is high. The navigation system starts up automatically when the system cools down.
System temp is too high. System will shut down until it cools down.	
HDD access error. Please consult your dealer.	Writing of the data to the HDD failed with a cause other than low temperature, high temperature, and low atmospheric pressure. After a short wait, try to operate the system again. If this does not solve the problem, consult with the dealer.
HDD access error. The system will reset and attempt to correct the problem.	

CD Player

If a disc error occurs, you may see the following error messages.

Error Message	Cause	Solution
Unplayable File	Track/file format not supported	<ul style="list-style-type: none"> • Current track/file will be skipped. The next supported track/file plays automatically.
Bad Disc Please Check Owner's Manual Push Eject	Mechanical error	<ul style="list-style-type: none"> • Press the  (eject) button and remove the disc, and check that the error message is cleared. • Check that the disc is not damaged or deformed, and insert the disc again.
Mecha Error		<p> Protecting CDs P. 164</p>
Bad Disc Please Check Owner's Manual	Servo error	<ul style="list-style-type: none"> • If the error message reappears, press the  button, and pull out the disc. • Insert a different disc. • If the new disc plays, there is a problem with the first disc. • If the error message repeats, or the disc cannot be removed, contact a dealer. <p>Do not try to force the disc out of the player.</p>
Check Disc	Disc error	<ul style="list-style-type: none"> • Check that the disc is not damaged or deformed. <p> Protecting CDs P. 164</p>
Heat Error	High temperature	<ul style="list-style-type: none"> • Turn the audio system off and allow the player to cool down until the error message is cleared.

Hard Disc Drive (HDD) Audio

If an error occurs while playing the Hard Disc Drive (HDD) Audio, you may see the following error messages. If you cannot clear the error message, contact a dealer.

Error Message	Solution
HDD access error. Please consult your dealer.	—
The display system temperature is too high. For protection, the system will shut off until the display cools down.	Turn the audio system off and allow the player to cool down until the error message is cleared.
The navigation system temperature is too low. For protection, the system will shut off until it warms up.	The navigation system has difficulty reading the HDD when the temperature is below approximately -22°F (-30°C). The navigation system starts up automatically when the display warms up.
Unplayable File	Appears when a file format not supported. Current track will be skipped. The next supported track plays automatically.

iPod®/USB Flash Drive

If an error occurs while playing an iPod® or USB flash drive, you may see the following error messages. If you cannot clear the error message, contact a dealer.

Error Message	Solution
USB Error	Appears when there is a problem with the audio system. Check if the device is compatible with the audio system.
Incompatible USB Device Please Check Owner's Manual	Appears when an incompatible device is connected. Disconnect the device. Then turn the audio system off, and turn it on again. Do not reconnect the device that caused the error.
Unsupported Version	Appears when an unsupported iPod® is connected. If it appears when a supported iPod® is connected, update the iPod® software to the newer version.
Connect Retry	Appears when the system does not acknowledge the iPod®. Reconnect the iPod®.
Unplayable File	Appears when the files in the USB flash drive are DRM or an unsupported format. This error message appears for about 3 seconds, then plays the next song.
No Data	<p>iPod® Appears when the iPod® is empty.</p> <p>USB flash drive Appears when the USB flash drive is empty or there are no MP3, WMA, or AAC files in the USB flash drive.</p> <p>iPod® and USB flash drive Check that compatible files are stored on the device.</p>
Unsupported	Appears when an unsupported device is connected. If it appears when a supported device is connected, reconnect the device.

Pandora®

If an error occurs while playing Pandora®, you may see the following error messages.

If you cannot clear the error message, contact a dealer.

Error Message	Solution
Incompatible USB Device Please Check Owner's Manual	Appears when an incompatible device is connected. Disconnect the device. Then turn the audio system off, and turn it again. Do not reconnect the device that caused the error.
Navigation Screen There is no station list in the device. Please add the station list to your device. Touchscreen No stations have been created. Please create a station on the device.	Appears when there is no station list on the device. Use the device to create a station.
Music licenses force us to limit the number of tracks you may skip each hour.	Appears when you try to skip a song or select Dislike over the predetermined number of times in an hour.
Unable to save rating. Unable to save bookmark or Unable to skip	Appears when the commanded operation is failed. Try again later.
No data	Appears when no data is available with Pandora® activated. Reboot the app and reconnect the device.
PANDORA ver unsupported	Appears when Pandora® version is not supported. Update Pandora® to the latest version.
PANDORA system maintenance	Appears when the Pandora® server is in maintenance. Try again later.
Cannot connect to PANDORA when stopped. Check your mobile phone	Appears when Pandora® is unable to play music. Check your device.

Aha™ Radio

If an error occurs while playing Aha™ Radio, you may see the following error messages.

If you cannot clear the error message, contact a dealer.

Error Message	Solution
Cannot connect to HondaLink. When stopped, check your mobile device.	Appears when the Aha™ app is not activated. Check your device.
Incompatible USB Device Please Check Owner's Manual	Appears when an incompatible device is connected. Disconnect the device. Then turn the audio system off, and turn it on again. Do not reconnect the device that caused the error.

Reference Information

System Initialization	292	Visiting a Dealer	296
Entering the Security Code	292	Map Coverage	297
Acquiring GPS Information	292	Obtaining a Navigation Update	297
Startup Confirmation Screen	293	Traffic Information	298
Map Matching	293	Operation in Alaska, Hawaii, Canada, Puerto Rico, and Mexico	298
System Limitations	294	Legal Information	299
GPS System	294	Copyrights	299
Address Calculation	294	User Agreements	299
Database	294	As required by the FCC	305
Customer Assistance	296		
Resolving Problems	296		
Reporting Errors	296		
Honda Automobile Customer Service Contact Information	296		

The navigation system must be initialized if power to the navigation system is interrupted for any reason (e.g., the battery was disconnected).

Entering the Security Code

In most cases, you do not need to enter a security code. Follow the steps to reactivate the system.

Enter code

To enter the security code automatically, push and hold the audio power button for 2 seconds. If this does not work, manually enter the security code using the touch panel below.

1. Set the power mode to ON, and turn on the audio system.
2. Press and hold the  (Power) button for more than two seconds.
 - ▶ The system is reactivated when the system's control unit recognizes that the system is in your vehicle. If the control unit fails to recognize, you must go to a dealer and have the system checked.

Acquiring GPS Information

Depending on the length of time the power was interrupted, your system may require GPS initialization.

The navigation system lost power and is acquiring its location from the GPS satellites. This usually takes less than 10 minutes.

- * Start the engine.
- * Park the vehicle in an open area away from trees, power lines, and tall buildings.
- * Remove loose articles, mobile phones, or electrical accessories located near the GPS antenna.
- * If this screen is displayed repeatedly when starting the vehicle, see your dealer.

If initialization is not necessary, the system proceeds directly to the Startup Confirmation screen.

If the system fails to locate a sufficient number of satellites to locate your position within 10 minutes, the following screen is displayed.

Something is interfering with the system's ability to acquire its location. Check the following:

- * The vehicle must be in an open area with a clear view of the sky.
- * Remove sources of GPS interference like metallic window tint above antenna, or electrical items near antenna (see owner's manual for details).
- * Check GPS antenna cable connection.
- * Restart the engine and repeat the GPS acquire procedure. If the problem persists, see your dealer.

If you are experiencing GPS reception problems:

➤ **GPS System P. 294**

Startup Confirmation Screen

The Startup Confirmation screen is displayed when initialization has successfully completed. It is displayed every time you start your vehicle. Press  to select **OK** to continue.



Map Matching

Map matching is the process of using the acquired GPS information to locate your position on the map screen. If you are on a mapped road, the name of the road is displayed along the bottom of the map screen when map matching is completed. Do not enter a destination until the road name is displayed.

The system may initially show your location on a different street (e.g., in urban areas where streets are close together), may show an incorrect elevation, or may delay the display of the vehicle position icon at intersections. This is normal; the system will correct itself while you drive.

GPS System

The signals received from the GPS satellites are extremely weak (less than a millionth of the strength of a local FM station) and require an unobstructed view of the sky. The GPS antenna is located in the dashboard. The signal reception can easily be interrupted or interfered with by the following:

- Metallic window tint on the front or side windows
- Cell phones, PDAs, or other electronic devices docked in a cradle or lying loose on the dashboard
- Remote starters or “hidden” vehicle tracking systems mounted near the navigation unit
- Audio electronic devices mounted near the navigation unit
- Trees, tall buildings, freeway overpasses, tunnels, or overhead electrical power wires

The GPS is operated by the U.S. Department of Defense. For security reasons, there are certain inaccuracies built into the GPS for which the navigation system must constantly compensate. This

can cause occasional positioning errors of up to several hundred feet.

Address Calculation

The destination icon shows only the approximate location of a destination address. This occurs if the number of possible addresses is different from the number of actual addresses on a block. For example, the address 1425 on a 1400 block with 100 possible addresses (because it is followed by the 1500 block) will be shown a quarter of the way down the block by the system. If there are only 25 actual addresses on the block, the actual location of address 1425 would be at the end of the block.

Database

The digitized map database reflects conditions as they existed at various points in time before production. Accordingly, your database may contain inaccurate or incomplete data or information due to the passage of time, road construction, changing conditions, or other causes.

For example, some places/landmarks may be missing when you search the database because the name was misspelled, the place was improperly categorized, or a place/landmark is not yet in the database. This is also true for police stations, hospitals, and other public institutions. Do not rely on the navigation system if you need law enforcement or hospital services. Always check with local information sources.

In addition, the map database contains verified and unverified areas. Unverified streets may be missing from the map, in the wrong location, or have an incorrect name or address range. A message will warn you if your route includes unverified streets. Exercise additional caution when driving in unverified areas.

The database does not include, analyze, process, consider, or reflect any of the following categories of information:

- Neighborhood quality or safety
- Population density
- Availability or proximity of law enforcement
- Emergency, rescue, medical, or other assistance
- Construction work, zones, or hazards
- Road and lane closures
- Legal restrictions (such as vehicular type, weight, load, height, and speed restrictions)
- Road slope or grade
- Bridge height, width, weight, or other limits
- Traffic facilities safety
- Special events

- Pavement characteristics or conditions

Every effort has been made to verify that the database is accurate. The number of inaccuracies you experience increases the longer you go without obtaining an updated map database.

🗲 **Obtaining a Navigation Update** P. 297

We assume no liability for any incident that may result from an error in the program, or from changed conditions not noted above.

Resolving Problems

If you run into a specific issue that you cannot resolve, consult the following help resources:

- For navigation system issues:
➤ **Troubleshooting** P. 278
There are also FAQs available online at www.hondanavi.com.
- For traffic-related issues:
➤ **Traffic** P. 280
- For reporting issues with the database or places/landmarks:
➤ **Reporting Errors** P. 296
- Call Honda Automobile Customer Service.
➤ **Honda Automobile Customer Service Contact Information** P. 296

Reporting Errors

You can help to improve database accuracy by reporting any errors you encounter.

- Report errors in freeways and main “verified” roads shown in black on the map at <http://mapreporter.navteq.com/dur-web-external/>.
- Please do not report errors in purple “unverified” roads. Maps for these areas are provided for reference only.
➤ **Unverified Routing** P. 51
- Please do not report errors in places/landmarks, such as changes in business names. Information about points of interest are constantly being updated. An updated database is available for purchase, usually in the fall of each year.
➤ **Obtaining a Navigation Update** P. 297
- For vehicle position icon errors, screen error messages, or other GPS-related errors:
➤ **Troubleshooting** P. 278
➤ **System Limitations** P. 294

Honda Automobile Customer Service Contact Information

Honda Navi

American Honda Motor Co., Inc.

Honda Automobile Customer Service
Mail Stop 500-2N-7E
1919 Torrance Blvd.

Torrance, CA 90501-2746
Tel: (800) 999-1009
Fax: (310) 783-3273

Visiting a Dealer

If you have a question that you cannot resolve using the available help resources, you can consult a dealer. Please identify the specific issue (e.g., error occurs when you enter a specific address, when driving on a certain road, or just when it’s cold) so that the service technician can refer the issue to the factory so that a solution can be found. Be patient, the service technician may be unfamiliar with your specific issue.

Map Coverage

The navigation system provides map coverage for the United States, Canada, Puerto Rico, and Mexico. The map coverage consists of accurately mapped (verified) metropolitan areas and a less accurate (unverified) rural database. Note that unverified areas are constantly being reviewed and converted to verified areas each year.



Map coverage update information is available from Honda Automobile Customer Service or online at www.hondanavi.com.

To find navigation system update information:

1. Visit www.hondanavi.com.
2. Enter your vehicle model and model year.
3. Click Map Coverage to display a list of verified coverage areas on the most recent update.
4. Click Map Coverage Details to display a PDF document with a full listing of all coverage areas.
 - ▶ Adobe® Reader® is required for viewing and printing the Portable Document Format (PDF) documents. To download the latest version of Adobe Reader, visit <http://get.adobe.com/reader/>.

Obtaining a Navigation Update

Honda is continually expanding the scope of the navigation system. Navigation system software upgrades may be made available periodically, usually in the fall of each year.

To purchase an update:

1. Obtain your vehicle's VIN number and the System/Device Information.
 - ▶ **System Device Information P. 272**
2. Call the Honda Navigation Disc Fulfillment Center at (888) 291-4675, or order online at www.hondanavi.com.

An update is not available from a dealer. However, the dealer may assist you in obtaining one for you out of courtesy. There is no program for free updates.

Traffic Information

- Continuously updated traffic information is available in major metropolitan areas across the 48 contiguous states and some cities in Canada. A list of coverage areas is available online.
- Visit automobiles.honda.com/traffic for a complete listing of coverage areas and other information.

Operation in Alaska, Hawaii, Canada, Puerto Rico, and Mexico

■ Map Coverage

All roads displayed on the map screens are verified roads. Information in this manual relating to “unverified” roads or areas is not applicable.

■ Address and Place Entry Screens

Entering a destination address or place/landmark on another island may result in a screen caution message. This is because there are no ferry routes between islands in the database.

■ Puerto Rico and Mexico

If **Street Name Guidance** is set to **On**, the street names will not be read out by voice guidance. This may change in a future data update.

Copyrights

- Infogroup-Data: Certain business data provided by Infogroup © 2011, All Rights Reserved.
- EXIT-Data: © ZENRIN CO., LTD. 2011. All rights reserved.
- Building foot print: © ZENRIN CO., LTD. 2011. All rights reserved.
- Junction View Data: © ZENRIN USA, INC. 2011. All rights reserved.
- ZAGAT SURVEY: © 2012 Zagat Survey, LLC. Zagat Survey is a registered trademark of Zagat Survey, LLC. The Zagat Content displayed may not reflect the most up-to-date Zagat Content available to the public.
- Brand icon: The marks of companies displayed by this product to indicate business locations are the marks of their respective owners. The use of such marks in this product does not imply any sponsorship, approval, or endorsement by such companies of this product.

User Agreements

Navigation System User Agreement

In using this HDD “Satellite Linked Navigation System” (the “HDD”), which includes HONDA MOTOR CO., LTD. software, ALPINE ELECTRONICS, INC. software, and NAVTEQ database contents (hereinafter referred to as “Licensors”), you are bound by the terms and conditions set forth below. By using your copy of the HDD, you have expressed your Agreement to the terms and conditions of this Agreement. You should, therefore, make sure that you read and understand the following provisions. If for any reason you do not wish to be bound by the terms of this Agreement, please return the HDD to your dealer.

- The HDD may not be copied, duplicated, or otherwise modified, in whole or in part, without the express written permission of the Licensors.
- The HDD may not be transferred or sublicensed to any third party for profit, rent or loan, or licensed for reuse in any manner.

- The HDD may not be decompiled, reverse engineered or otherwise disassembled, in whole or in part.
- The HDD may not be used in a network or by any other manner of simultaneous use in multiple systems.
- The HDD is intended solely for personal use (or internal use where the end-user is a business) by the consumer. The HDD is not to be used for commercial purposes.
- The Licensors do not guarantee to the client that the functions included in the HDD meet the specific objectives of the user.
- Licensors shall not be responsible for any damages caused by the use of the HDD to the actual user or to any third party.
- The warranty on the HDD shall not extend to an exchange or refund due to misspelling, omission of letters, or any other cosmetic discrepancy in the contents of the HDD.
- The right to use the HDD shall expire either when the user destroys the HDD or software, or when any of the terms of this Agreement are violated and the Licensors exercise the option to revoke the license to use the HDD or software.

- The terms and conditions hereof apply to all subsequent users and owners as well as to the original purchaser.
- The logos of oil companies, hotels, convenience stores, and other businesses are displayed for your information and convenience, and in no way imply any sponsorship, approval or endorsement of these companies, or their products. The logos are trademarks of their respective owners.
- The marks of companies displayed by this product to indicate business locations are the marks of their respective owners.
- The use of such marks in this product does not imply any sponsorship, approval, or endorsement by such companies of this product.

The user shall indemnify and save harmless the Licensors, and their officers, employees and agents, from and against any claim, demand or action, irrespective of the nature of the cause of the claim, demand or action, alleging loss, costs, expense, damages or injuries (including injuries resulting in death) arising out of the use or possession of the HDD or software.

Use, duplication, or disclosure of this HDD by or on behalf of the United States government is subject to "Restricted Rights" as set forth at FAR 52.227-14, -19 or DFARS 252.227-7013, as applicable. Manufacturers are the Licensors, including HONDA MOTOR CO., LTD., 2-1-1 Minami Aoyama Minato-Ku Tokyo 107-8556 JAPAN., Alpine Electronics, Inc., 20-1 Yoshima Kogyodanchi, Iwaki, Fukushima 970-1192 JAPAN., NAVTEQ Corporation, 425 W Randolph St. Chicago, IL 60606, USA.

■ Navigation System END USER LICENSE AGREEMENT

You have acquired a device ("DEVICE") that includes software licensed by Alpine Electronics, Inc. (collectively "ALPINE") from an affiliate of Microsoft Corporation (collectively "MS"). Those installed software products of MS origin, as well as associated media, printed materials, and "online" or electronic documentation ("SOFTWARE") are protected by international intellectual property laws and treaties. The SOFTWARE is licensed, not sold. All rights reserved.

IF YOU DO NOT AGREE TO THIS END USER LICENSE AGREEMENT ("EULA"), DO NOT USE THE DEVICE OR COPY THE SOFTWARE INSTEAD, PROMPTLY CONTACT ALPINE FOR INSTRUCTIONS ON RETURN OF THE UNUSED DEVICE(S) FOR A REFUND. ANY USE OF THE SOFTWARE, INCLUDING BUT NOT LIMITED TO USE ON THE DEVICE, WILL CONSTITUTE YOUR AGREEMENT TO THIS EULA (OR RATIFICATION OF ANY PREVIOUS CONSENT).

- GRANT OF SOFTWARE LICENSE
This EULA grants you the following license: You may use the SOFTWARE only on the DEVICE.
- NOT FAULT TOLERANT
THE SOFTWARE IS NOT FAULT TOLERANT. ALPINE HAS INDEPENDENTLY DETERMINED HOW TO USE THE SOFTWARE IN THE DEVICE, AND MS HAS RELIED UPON ALPINE TO CONDUCT SUFFICIENT TESTING TO DETERMINE THAT THE SOFTWARE IS SUITABLE FOR SUCH USE.
- NO WARRANTIES FOR THE SOFTWARE
THE SOFTWARE is provided "AS IS" and with all faults. THE ENTIRE RISK AS TO SATISFACTORY QUALITY, PERFORMANCE, ACCURACY, AND

EFFORT (INCLUDING LACK OF NEGLIGENCE) IS WITH YOU. ALSO, THERE IS NO WARRANTY AGAINST INTERFERENCE WITH YOUR ENJOYMENT OF THE SOFTWARE OR AGAINST INFRINGEMENT. IF YOU HAVE RECEIVED ANY WARRANTIES REGARDING THE DEVICE OR SOFTWARE THOSE WARRANTIES DO NOT ORIGINATE FROM, AND ARE NOT BINDING ON, MS.

- NO LIABILITY FOR CERTAIN DAMAGES. EXCEPT AS PROHIBITED BY LAW, MS, MICROSOFT CORPORATION AND THEIR AFFILIATES SHALL HAVE NO LIABILITY FOR ANY INDIRECT, SPECIAL, CONSEQUENTIAL OR INCIDENTAL DAMAGES ARISING FROM OR IN CONNECTION WITH THE USE OR PERFORMANCE OF THE SOFTWARE. THIS LIMITATION SHALL APPLY EVEN IF ANY REMEDY FAILS OF ITS ESSENTIAL PURPOSE. IN NO EVENT SHALL MS, MICROSOFT CORPORATION AND/OR THEIR AFFILIATES BE LIABLE FOR ANY AMOUNT IN EXCESS OF U.S. TWO HUNDRED FIFTY DOLLARS (U.S.\$250.00).

- SPEECH RECOGNITION

If the SOFTWARE includes speech recognition component(s), you should understand that speech recognition is an inherently statistical process and that recognition errors are inherent in the process. Neither ALPINE nor its suppliers shall be liable for any damages arising out of errors in the speech recognition process.

- LIMITATIONS ON REVERSE ENGINEERING, DECOMPIATION, AND DISASSEMBLY

You may not reverse engineer, decompile, or disassemble the SOFTWARE, except and only to the extent that such activity is expressly permitted by applicable law notwithstanding this limitation.

- ADDITIONAL SOFTWARE/SERVICES

The SOFTWARE may permit ALPINE, MS, Microsoft Corporation or their affiliates to provide or make available to you SOFTWARE updates, supplements, add-on components, or Internet-base service components of the SOFTWARE after the date you obtain your initial copy of the SOFTWARE ("Supplemental Components").

- ▶ If ALPINE provides or makes available to you Supplemental Components and no other EULA terms are provided along with the Supplemental Components, then the terms of this EULA shall apply.

- ▶ If MS, Microsoft Corporation or their affiliates make available Supplemental Components, and no other EULA terms are provided, then the terms of this EULA shall apply, except that MS, Microsoft Corporation or affiliate entity providing the Supplemental Component(s) shall be licensor of the Supplemental Component(s).

- ▶ ALPINE, MS, Microsoft Corporation and their affiliates reserve the right to discontinue any Internet-based services provided to you or made available to you through the use of the SOFTWARE.

- RECOVERY MEDIA

If SOFTWARE is provided by ALPINE on separate media and labeled "Recovery Media" you may use the Recovery Media solely to restore or reinstall the SOFTWARE originally installed on the DEVICE.

- **UPGRADES**

If the SOFTWARE is provided by ALPINE separate from the DEVICE on separate media or via web download or other means, and is labeled "For Upgrade Purposes Only" you may install one (1) copy of such SOFTWARE onto the DEVICE as a replacement copy for the existing SOFTWARE, and use it in accordance with this EULA, including any additional EULA terms accompanying the upgrade SOFTWARE.

- **TERMINATION**

Without prejudice to any other rights, ALPINE or MS may terminate this EULA if you fail to comply with the terms and conditions of this EULA. In such event, you must destroy all copies of the SOFTWARE and all of its component parts.

- **INTELLECTUAL PROPERTY RIGHTS**

All title and intellectual property rights in and to the SOFTWARE (including but not limited to any images, photographs, animations, video, audio, music, text and "applets," incorporated into the SOFTWARE), the accompanying printed materials, and any copies of the SOFTWARE, are owned by MS, Microsoft Corporation, their affiliates or

suppliers. The SOFTWARE is licensed, not sold.

You may not copy the printed materials accompanying the SOFTWARE. All title and intellectual property rights in and to the content which may be accessed through use of the SOFTWARE is the property of the respective content owner and may be protected by applicable copyright or other intellectual property laws and treaties. This EULA grants you no rights to use such content. All rights not specifically granted under this EULA are reserved by MS, Microsoft Corporation, their affiliates and suppliers. Use of any on-line services which may be accessed through the SOFTWARE may be governed by the respective terms of use relating to such services. If this SOFTWARE contains documentation that is provided only in electronic form, you may print one copy of such electronic documentation.

- **TRADEMARKS**

This EULA does not grant you any rights in connection with any trademarks or service marks of ALPINE MS, Microsoft Corporation, their affiliates or suppliers.

- **PRODUCT SUPPORT**

Product support for the SOFTWARE is not provided by MS, its parent corporation Microsoft Corporation, or their affiliates or subsidiaries. For product support, please refer to ALPINE support number provided in the documentation for the DEVICE. Should you have any questions concerning this EULA, or if you desire to contact ALPINE for any other reason, please refer to the address provided in the documentation for the DEVICE.

- **SOFTWARE TRANSFER ALLOWED BUT WITH RESTRICTIONS**

You may permanently transfer rights under this EULA only as part of a permanent sale or transfer of the Device, and only if the recipient agrees to this EULA. If the SOFTWARE is an upgrade, any transfer must also include all prior versions of the SOFTWARE.

- **EXPORT RESTRICTIONS**

You acknowledge that SOFTWARE is of US-origin. You agree to comply with all applicable international and national laws that apply to the SOFTWARE, including the U.S. Export Administration Regulations, as well as end-user, end-use and country destination restrictions

issued by U.S. and other governments. For additional information on exporting the SOFTWARE, see <http://www.microsoft.com/exporting/>.

■ Gracenote Music Recognition Service (CDDB)



Music recognition technology and related data are provided by Gracenote®. Gracenote is the industry standard in music recognition technology and related content delivery.

For more information, visit www.gracenote.com.

When music is recorded to the HDD from a CD, information such as the recording artist and track name are retrieved from the Gracenote Database and displayed (when available).

Gracenote may not contain information for all albums.

Gracenote is an internet-based music recognition service that allows artist, album, and track information from CDs to display on the HDD.

Gracenote users are allowed 4 free updates a year. More information about Gracenote, its features, and downloads are

available at www.honda.com (in U.S.) or www.honda.ca (in Canada).

CD and music-related data from Gracenote, Inc., copyright © 2000 to present Gracenote. Gracenote Software, copyright © 2000 to present Gracenote.

One or more patents owned by Gracenote apply to this product and service. See the Gracenote website for a non-exhaustive list of applicable Gracenote patents. Gracenote, CDDB, MusicID, MediaVOCS, the Gracenote logo and logotype, and the “Powered by Gracenote” logo are either registered trademarks or trademarks of Gracenote in the United States and/or other countries.

■ Gracenote® END USER LICENSE AGREEMENT

This application or device contains software from Gracenote, Inc. of Emeryville, California (“Gracenote”). The software from Gracenote (the “Gracenote Software”) enables this application to perform disc and/or file identification and obtain music-related information, including name, artist, track, and title information (“Gracenote Data”) from online servers or embedded databases

(collectively, "Gracenote Servers") and to perform other functions. You may use Gracenote Data only by means of the intended End-User functions or this application or device.

You agree that you will use Gracenote Data, the Gracenote Software, and Gracenote Servers for your own personal non-commercial use only.

You agree not to assign, copy, transfer, or transmit the Gracenote Software or any Gracenote Data to any third party.

YOU AGREE NOT TO USE OR EXPLOIT GRACENOTE DATA, THE GRACENOTE SOFTWARE, OR GRACENOTE SERVERS, EXCEPT AS EXPRESSLY PERMITTED HEREIN.

You agree that your non-exclusive license to use the Gracenote Data, the Gracenote Software, and Gracenote Servers will terminate if you violate these restrictions. If your license terminates, you agree to cease any and all use of the Gracenote Data, the Gracenote Software, and Gracenote Servers.

Gracenote reserves all rights in Gracenote Data, the Gracenote Software, and the Gracenote Servers, including all ownership

rights. Under no circumstances will Gracenote become liable for any payment to you for any information that you provide. You agree that Gracenote, Inc. may enforce its rights under this Agreement against you directly in its own name.

The Gracenote service uses a unique identifier to track queries for statistical purposes. The purpose of a randomly assigned numeric identifier is to allow the Gracenote service to count queries without knowing anything about who you are. For more information, see the web page for the Gracenote Privacy Policy for the Gracenote service.

The Gracenote Software and each item of Gracenote Data are licensed to you "AS IS."

Gracenote makes no representations or warranties, express or implied, regarding the accuracy of any Gracenote Data from in the Gracenote Servers. Gracenote reserves the right to delete data from the Gracenote Servers or to change data categories for any cause that Gracenote deems sufficient. No warranty is made that the Gracenote Software or Gracenote Servers are error-free or that functioning of

Gracenote Software or Gracenote Servers will be uninterrupted.

Gracenote is not obligated to provide you with new enhanced or additional data types or categories that Gracenote may provide in the future and is free to discontinue its services at any time.

GRACENOTE DISCLAIMS ALL WARRANTIES EXPRESS OR IMPLIED, INCLUDING, BUT NOT LIMITED TO, IMPLIED WARRANTIES OF MERCHANTABILITY, FITNESS FOR A PARTICULAR PURPOSE, TITLE, AND NONINFRINGEMENT. GRACENOTE DOES NOT WARRANT THE RESULTS THAT WILL BE OBTAINED BY YOUR USE OF THE GRACENOTE SOFTWARE OR ANY GRACENOTE SERVER. IN NO CASE WILL GRACENOTE BE LIABLE FOR ANY CONSEQUENTIAL OR INCIDENTAL DAMAGES OR FOR ANY LOST PROFITS OR LOST REVENUES.

copyright © 2000 to present Gracenote

As required by the FCC

1. This device complies with Part 15 of the FCC Rules and Canadian RSS-210/ RSSGen. Operation is subject to the following two conditions: (1) this device may not cause harmful interference, and (2) this device must accept any interference received, including interference that may cause undesired operation.
2. The FCC requires the user to be notified that any changes or modifications made to this device that are not expressly approved by the party responsible for compliance may void the user's authority to operate the equipment.
3. This product emits radio frequency energy, but the radiated output power of this device is far below the FCC and IC radio frequency exposure limits. This equipment complies with FCC and IC RF radiation exposure limits set forth for an uncontrolled environment. Nevertheless, the device should be used in such a manner that the potential for human contact with the antenna during normal operation is minimized.



Voice Commands

- Voice Commands** 308
 - Navigation Commands 308
 - Voice Portal Commands 310
 - Phone Commands 310
 - Info Commands 311
 - Climate Control Commands 311
 - Audio Commands 312
 - On-Screen Commands 316
 - Spelling Assistance 316

Navigation Commands

The system accepts these commands on a map/guidance screen.

General Commands

Display phone (equivalent to PHONE)
Display audio (equivalent to AUDIO)
Display navigation (if en route, displays the Route screen)
Display information (equivalent to INFO)
Display menu (equivalent to MENU. if en route, displays Route Options)
Display setting (equivalent to SETTING)
Display map
Display map guide (when en route, shows the next guidance point)
Display rear audio
Display front audio
Cancel
What time is it?
What is today's date?
Voice help (displays commands for current screen)

Map Display Commands

Display current location (shows current latitude, longitude, and elevation)
Display/Hide (specify icon type):
ATM
gas station
restaurant
post office
grocery store
lodging (hotel, motel)
parking garage
parking lot
school
hospital
freeway exit information
traffic
traffic speeds
traffic icons
traffic incidents
Go home
Register the current location (stores current location in the Address Book)

Map Scale Commands

Display north up
Display heading up
Display 3D map
Display zoom in
Display zoom out
Display (specify scale):
1/20 mile (80 m) scale
1/8 mile (200 m) scale
1/4 mile (400 m) scale
1/2 mile (800 m) scale
1 mile (1600 m) scale
2 mile (3 km) scale
5 mile (8 km) scale
15 mile (24 km) scale
50 mile (80 km) scale
150 mile (240 km) scale
350 mile (560 km) scale
1000 mile (1600 km) scale
Max zoom in
Max zoom out

Find Place Commands

Find nearest (specify place):

Fuel and auto

Honda dealers

Acura dealers

Gas station

Hydrogen station

Auto parts & electronics

Auto repair & maintenance

Car wash & detailing

Motorcycle dealers

Other car dealers

Roadside assistance

ATM and bank

ATM

Bank

Check cashing

Currency exchange

Community

Business

City hall

Civic center

Convention center

Court house

Higher education

Library

Post office

School

Emergency room

Hospital

Police station

Veterinarian

Lodging

Bed & breakfast

Hotel

Resort

Recreation

Amusement park

Golf course

Historical monument

Marina

Movie theater

Museum

Park

Performing arts

Sports complex

Tourist attraction

Restaurant

ZAGAT restaurant

American restaurant

Californian restaurant

Chinese restaurant

Coffee shop

Continental restaurant

Fast food

French restaurant

German restaurant

Greek restaurant

Indian restaurant

Italian restaurant

Japanese restaurant

Korean restaurant

Mexican restaurant

Pizza

Seafood restaurant

Thai restaurant

Vegetarian restaurant

Vietnamese restaurant

Other restaurant

Shopping

Shopping area

Accessory store

Book store

Clothing store

Grocery store

Home improvement store

Mall

Office supply store

Pharmacy

Pet food store

Sewing store

Shoe store

Sporting goods store

Toy store
Travel center
Airport
Automobile club
Bus station
Camping
Commuter rail station
Ferry terminal
Named place
Park & ride
Parking garage
Parking lot
Rental car agency
Rest area
Ski area
Tourist information
Train station
Travel agency
Truck stop

Route Commands

The system accepts these commands when a route is set.

*How long to the destination?**
*How far to the destination?**
Display destination map
Display entire route
Cancel route
Repeat guidance

* These commands are not available if you scroll through the map while en route to a destination.

Voice Portal Commands

The system accepts these commands on the **Voice Portal** screen.

- *Call Your contact name*
- *Call Phone Number*
- *Find nearest POI category name*
- *Go home*
- *Route menu*
- *Cancel route*

Phone Commands

The system accepts these commands on any screen.

- *Call by number*
- *Call by name*

Contacts that are imported from your phone to the vehicle are all made available by voice. Voice Tags can also be recorded for each of your Speed Dial entries.

Info Commands

The system accepts these commands on any screen.

- *Trip computer*
- *Traffic information*
- *Display clock*
- *Display wallpaper*

Climate Control Commands

The system accepts these commands on most screens.

- *Climate control automatic*^{*1}
- *Climate control off*^{*1}
- *Air conditioner on*^{*1}
- *Air conditioner off*^{*1}
- *Climate control defrost on*^{*1}
- *Climate control defrost off*^{*1}
- *Rear defrost on*^{*1}
- *Rear defrost off*^{*1}
- *Climate control fresh air*
- *Climate control recirculate*
- *Climate control vent*
- *Climate control bi-level*
- *Climate control floor*
- *Climate control floor and defrost*

- *Climate control mode automatic*
- *Fan speed up*
- *Fan speed down*
- *Fan speed # (#: 1 to 7)*
- *Fan automatic*
- *Rear lock on*
- *Rear lock off*
- *Temperature # degrees (#: 57 to 87°F, 15 to 29°C)*
- *Driver temperature # degrees (#: 57 to 87°F, 15 to 29°C)*
- *Passenger temperature # degrees (#: 57 to 87°F, 15 to 29°C)*
- *Temperature up*
- *Temperature down*
- *Driver temperature up*
- *Driver temperature down*
- *Passenger temperature up*
- *Passenger temperature down*
- *Temperature max heat*
- *Temperature max cool*
- *Driver temperature max heat*
- *Driver temperature max cool*
- *Passenger temperature max heat*
- *Passenger temperature max cool*
- *Climate control sync on*^{*1}
- *Climate control sync off*^{*1}
- *Front climate control automatic*
- *Front climate control off*

- *Rear climate control automatic*
- *Rear climate control off*
- *Rear climate control vent*
- *Rear climate control bi-level*
- *Rear climate control floor*
- *Rear fan speed up*
- *Rear fan speed down*
- *Rear fan speed # (#: 1 to 5)*
- *Rear temperature # degrees (#: 57 to 87°F, 15 to 29°C)*
- *Rear temperature up*
- *Rear temperature down*
- *Rear temperature max heat*
- *Rear temperature max cool*

*1: These commands toggle the function on and off, so the command may not match your intended action.

Audio Commands

The system accepts these commands on most screens.

Using Song By Voice™

Song By Voice™ is a feature that allows you to select music from your Hard Disc Drive or iPod® device using your voice.

To activate this mode, you must press the  (Talk) button on the **Voice Portal** screen and say: “*Music search.*”

Song By Voice™ commands

- *Music search*
- *Play album* (specify album)
- *Play artist* (specify artist)
- *Play composer* (specify composer)
- *Play genre* (specify genre)
- *Play playlist* (specify playlist)
- *Play song* (specify song)
- *What am I listening to?*
- *Who am I listening to?*
- *Who is this?*
- *What’s playing?*
- *Who’s playing?*
- *What album is this?*

HDD commands

- *Hard Disc Drive play*
- *Hard Disc Drive play track #* (#: 1 to 30)
- *Hard Disc Drive skip forward*
- *Hard Disc Drive skip back*
- *Hard Disc Drive album up**2
- *Hard Disc Drive album down**2
- *Hard Disc Drive track up*
- *Hard Disc Drive track down*
- *Hard Disc Drive playlist up**2
- *Hard Disc Drive playlist down**2
- *Hard Disc Drive track random**1
- *Hard Disc Drive track repeat**1
- *Hard Disc Drive track scan**1
- *Hard Disc Drive normal play*
- *What am I listening to?*
- *Who am I listening to?*
- *Who is this?*
- *What’s playing?*
- *Who’s playing?*
- *What album is this?*

*1: These commands toggle the function on and off, so the command may not match your intended action.

*2: These commands are available only in the corresponding playback mode.

For example, “*Artist*” commands are available only in “*Artist*” mode.

Radio commands

- *Audio on**1
- *Audio off**1
- *Radio on**1
- *Radio off**1
- *Radio select FM*
- *Radio select AM*
- *Radio tune to # FM*
(#: frequency from 87.7 to 107.9)
- *Radio tune to # AM*
(#: frequency from 530 [five thirty] to 1710 [seventeen ten])
- *Radio seek up*
- *Radio seek down*
- *Radio next station*
- *Radio preset #* (#: 1 to 12)
- *Radio FM preset #* (#: 1 to 12)
- *Radio AM preset #* (#: 1 to 6)
- *Radio scan**1
- *Radio select XM*
- *XM channel #*
(#: 0 to 255 [two fifty five])
- *XM channel up*
- *XM channel down*
- *XM category up*
- *XM category down*

- *XM preset #* (#: 1 to 12)
- *XM scan*^{*1}
- *XM category mode*
- *XM channel mode*

*1: These commands toggle the function on and off, so the command may not match your intended action.

NOTE:

Radio volume levels cannot be controlled using voice control.

■ Disc commands

- *Disc play*
- *Disc play track #* (#: 1 to 30)
- *Disc skip forward*
- *Disc skip back*
- *Disc track random*^{*1}
- *Disc track repeat*^{*1}
- *Disc track scan*^{*1}
- *Disc folder up*
- *Disc folder down*
- *Disc folder random*^{*1}
- *Disc folder repeat*^{*1}
- *Disc folder scan*^{*1}
- *Disc normal play*

*1: These commands toggle the function on and off, so the command may not match your intended action.

■ iPod® commands

- *iPod play*
- *iPod play track #* (#: 1 to 30)
- *iPod skip forward*
- *iPod skip back*
- *iPod track shuffle*^{*1}
- *iPod album shuffle*^{*1}
- *iPod track repeat*^{*1}
- *iPod normal play*
- *What am I listening to?*
- *Who am I listening to?*
- *Who is this?*
- *What's playing?*
- *Who's playing?*
- *What album is this?*

*1: These commands toggle the function on and off, so the command may not match your intended action.

■ USB commands

- *USB play*
- *USB play track #* (#: 1 to 30)
- *USB skip forward*
- *USB skip back*
- *USB track random*^{*1}
- *USB track repeat*^{*1}
- *USB track scan*^{*1}
- *USB folder up*
- *USB folder down*
- *USB folder random*^{*1}
- *USB folder repeat*^{*1}
- *USB folder scan*^{*1}
- *USB normal play*

*1: These commands toggle the function on and off, so the command may not match your intended action.

■ Bluetooth® Audio commands

- *Bluetooth Audio play*
- *Bluetooth Audio skip forward*
- *Bluetooth Audio skip back*
- *Bluetooth Audio group up*
- *Bluetooth Audio group down*
- *Bluetooth Audio pause*
- *Bluetooth Audio resume*

NOTE:

Bluetooth® Audio commands may not work on some phones or *Bluetooth®* Audio devices.

■ AUX commands

- *Auxiliary play*

■ Pandora® commands

The system accepts these commands while the Pandora® is playing.

- *Pandora play*
- *Pandora skip forward*
- *Pandora station up*
- *Pandora station down*
- *Pandora pause*
- *Pandora resume*
- *Pandora thumbs up*
- *Pandora thumbs down*

■ Aha™ Radio commands

The system accepts these commands while the Aha™ is playing.

- *Aha radio play*
- *Aha radio skip forward*
- *Aha radio skip back*
- *Aha radio station up*
- *Aha radio station down*
- *Aha radio resume*
- *Aha radio pause*
- *Aha radio like*
- *Aha radio dislike*

■ Internet service commands

- *Internet service play*
- *Internet service skip forward**¹
- *Internet service skip back**¹
- *Internet service station up**¹
- *Internet service station down**¹
- *Internet service resume**¹
- *Internet service pause**¹
- *Internet service like**¹
- *Internet service dislike**¹

*1: The system accepts these commands while the Internet service is playing.

■ Rear Radio Commands

- Rear audio on**
- Rear audio off**
- Rear radio on**
- Rear radio off**
- Rear radio select FM*
- Rear radio select AM*
- Rear radio tune to # FM (#: frequency, e.g., 95.5)*
- Rear radio tune to # AM (#: frequency, e.g., 1020)*
- Rear radio seek up*
- Rear radio seek down*
- Rear radio next station*

Rear radio preset # (#: 1 to 12)
Rear radio FM preset # (#: 1 to 12)
Rear radio AM preset # (#: 1 to 6)
*Rear radio scan**
Rear radio select XM
Rear XM channel # (#: 0 to 255)
Rear XM channel up
Rear XM channel down
Rear XM category up
Rear XM category down
Rear XM preset # (#: 1 to 12)
*Rear XM scan**
Rear XM category mode
Rear XM channel mode

* These commands toggle the function between on and off, so the command may not match your intended action.

NOTE:

Radio volume levels cannot be controlled using voice control.

■ Rear CD Commands

Rear CD play
Rear CD play track # (#: 1 to 30)
Rear CD skip forward
Rear CD skip back
*Rear CD track random**
*Rear CD track repeat**
*Rear CD track scan**
Rear CD normal play (resumes "Play" from the random-, repeat-, or scan-play)
Rear CD folder up
Rear CD folder down
*Rear CD folder random**
*Rear CD folder repeat**
*Rear CD folder scan**

* These commands toggle the function between on and off, so the command may not match your intended action.

■ Rear DVD Commands

Rear DVD play
Rear DVD pause
Rear DVD title up
Rear DVD title down
Rear DVD chapter up
Rear DVD chapter down
Rear DVD title # (#: 1 to 30)
Rear DVD chapter # (#: 1 to 30)
Rear DVD title #1 chapter #2 (#1, #2: 1 to 30)
Rear DVD play track # (#: 1 to 30)
Rear DVD skip forward
Rear DVD skip back
*Rear DVD track random**
*Rear DVD track repeat**
*Rear DVD track scan**
Rear DVD normal play (resumes "Play" from the random-, repeat-, or scan-play)
*Rear DVD folder random**
*Rear DVD folder repeat**
*Rear DVD folder scan**

* These commands toggle the function between on and off, so the command may not match your intended action.

■ Rear HDD Commands

Rear HDD play
Rear HDD skip forward
Rear HDD skip back
Rear HDD album up
Rear HDD album down
Rear HDD track up
Rear HDD track down
Rear HDD playlist up
Rear HDD playlist down
*Rear HDD track random**
*Rear HDD track repeat**
*Rear HDD track scan**
Rear HDD normal play (resumes "Play"
 from the random-, repeat-, or scan-play)

* These commands toggle the function between on and off, so the command may not match your intended action.

■ Rear iPod Commands

Rear iPod play
Rear iPod skip forward
Rear iPod skip back
*Rear iPod track shuffle**
*Rear iPod album shuffle**
*Rear iPod track repeat**
Rear iPod normal play (resumes "Play"
 from the shuffle- or repeat-play)

* These commands toggle the function between on and off, so the command may not match your intended action.

■ Rear AUX Commands

Rear AUX play (or Rear Auxiliary play)

On-Screen Commands

The system accepts these commands on any screen. There are over 100 on-screen commands. Say what is written on the screen to activate that selection. For lists, you can say the list item number to select that item.

Next (or Down)

Previous (or Up)

Return

OK (excluding Startup Confirmation screen)

Delete

Spelling Assistance

The voice control system can also recognize phonetic alphabet input for numbers, letters, accented letters, punctuation marks, and symbols.

NOTE:

When selecting letters using the voice control system, a confirmation box may pop up to confirm the entry.

Numbers



Say ...	Say ... or Number ...
1	One
2	Two
3	Three
4	Four
5	Five
6	Six
7	Seven
8	Eight
9	Nine
0	Zero

Letters



Say ...	Or say...
A	Apple/Alpha
B	Boy/Bravo
C	Charlie
D	Dog/Delta
E	Edward/Echo
F	Frank/Foxtrot
G	George/Golf
H	Henry/Hotel
I	Igloo/India
J	John/Juliet
K	King/Kilo
L	Larry/Lima
M	Mary/Mike

Say ...	Or say...
N	Nancy/November
O	Oscar
P	Paul/Papa
Q	Queen/Quebec
R	Robert/Romeo
S	Sam/Sierra
T	Tom/Tango
U	Uncle/Uniform
V	Victor
W	William/Whiskey
X	X-ray
Y	Yellow/Yankee
Z	Zebra/Zulu

Accented Letters



Say ...	Say ... or Symbol ...
Á	A acute
À	A grave
Â	A circumflex
Ã	A umlaut
Ç	C cedilla
È	E grave
É	E acute
Ê	E circumflex
Ë	E umlaut
Í	I acute
Î	I circumflex
Ï	I umlaut
Ó	O acute

Say ...	Say ... or Symbol ...
Ô	O circumflex
Ö	O umlaut
Ù	U grave
Ú	U acute
Û	U circumflex
Ü	U umlaut

Symbols



Say ...	Say ... or Symbol ...
?	Question mark
!	Exclamation point
\$	Dollar
#	Pound
*	Asterisk
+	Plus
-	Hyphen
:	Colon
;	Semicolon
/	Slash
@	At sign
&	Ampersand
~	Tilde

Say ...	Say ... or <i>Symbol ...</i>
.	Dot
"	Double quote
,	Comma
'	Apostrophe
¡	Inverted exclamation point
¿	Inverted question mark
«	Left-pointing double angle quotation mark
»	Right-pointing double angle quotation mark
%	Percent
_	Underscore
<	Less than
>	Greater than
{	Open brace
}	Close brace
^	Caret
`	Back quote

List of Categories

Fuel/Auto		Lodging		Shopping	
All Types	Auto Repair & Maintenance	All Types	Hotel/Motel	All Types	Mall/Department Store
Honda Dealers	Car Wash & Detailing	Bed & Breakfast	Resort	Accessories/Jewelry	Office Supplies/Electronics
Acura Dealers	Motorcycle Dealers	Recreation		Auto Parts & Electronics	Pharmacy/Drug Store
Gas Station	Other Car Dealers	All Types	Museum	Books/Music/Video	Pet Food/Supplies
Hydrogen Station	Roadside Assistance	Amusement Park	Park/Recreation Area	Clothing	Sewing/Linen
Auto Parts & Electronics		Golf Course	Performing Arts	Shoes/Bags	Sporting Goods
ATM/Bank		Historical Monument	Sports Complex	Groceries	Toys/Arts/Crafts
All Types	Check Cashing/Money Transfer	Marina	Tourist Attraction	Travel	
ATM	Currency Exchange	Movie Theater		All Types	Parking Garage/House
Bank		Restaurant		Airport	Parking Lot
Community		All Types	Indian	Automobile Club	Rental Car Agency
All Types	Court House	All Types (Zagat Only)	Italian	Bed & Breakfast	Resort
Business	Higher Education	American	Japanese	Bus Station	Rest Area
City Hall	Library	Café/Coffee shop	Korean	Camping	Ski Area
Civic/Community Center	Post Office	Californian	Mexican	Commuter Rail Station	Tourist Attraction
Convention/Exhibition Center	School	Chinese	Pizza	Ferry Terminal	Tourist Information
Emergency		Continental	Seafood	Hotel/Motel	Train Station
All Types	Roadside Assistance	Fast Food	Thai	Named Place	Travel Agency
Hospital	Veterinarian	French	Vegetarian	Park & Ride	Truck Stop/Plaza
Police Station		German	Vietnamese		
		Greek	Other		

List of Language Codes

Language	Input Code
Abubasia	0102
Afar	0101
Afrikaans	0106
Albanian	1917
Amharic	0113
Arabic	0118
Armenian	0825
Assamese	0119
Aymara	0125
Azerbaijani	0126
Bashkir	0201
Basque	0521
Belarussian	0205
Bengali	0214
Bhutanese	0426
Bihari	0208
Bislama	0209
Breton	0218
Bulgarian	0207
Burmese	1325
Cambodian	1113
Catalan	0301
Chinese	2608

Language	Input Code
Corsican	0315
Croatian	0818
Czech	0319
Danish	0401
Dutch	1412
English	0514
Esperanto	0515
Estonian	0520
Faroese	0615
Fijian	0610
Finnish	0609
French	0618
Frisian	0625
Galician	0712
Georgian	1101
German	0405
Greek	0512
Greenlandic	1112
Guarani	0714
Gujarati	0721
Hausa	0801
Hebrew	0923
Hindi	0809



Language	Input Code
Hungarian	0821
Icelandic	0919
Indonesian	0914
Interlingue	0905
International	0901
Inupiaq	0911
Irish	0701
Italian	0920
Japanese	1001
Javanese	1023
Kannada	1114
Kashmiri	1119
Kazakh	1111
Kinyarwanda	1823
Kirghiz	1125
Kirundi	1814
Korean	1115
Kurdish	1121
Laotian	1215
Latvian	1222
Lingala	1214
Lithuanian	1220
Macedonian	1311

Language	Input Code
Malagasy	1307
Malay	1319
Malayalam	1312
Maltese	1320
Maori	1309
Marathi	1318
Moldavian	1315
Mongolian	1314
Nauruan	1401
Nepali	1405
Norwegian	1415
Oriya	1518
Oromo	1513
Pashto	1619
Persian	0601
Polish	1612
Portuguese	1620
Provençal	1503
Punjabi	1601
Quechua	1721
Rhaeto-Romance	1813
Romanian	1815
Russian	1821

Language	Input Code
Sand	1907
Sanskrit	1901
Scottish Gaelic	0704
Serbian	1918
Serbo-Croatian	1908
Seth-Thu	1920
Setswana	2014
Shona	1914
Sindhi	1904
Sinhalese	1909
SiSwati	1919
Slovak	1911
Slovene	1912
Somali	1915
Somoan	1913
Spanish	0519
Sundanese	1921
Swahili	1923
Swedish	1922
Tagalog	2012
Tajir	2007
Tamil	2001
Tartar	2020

Language	Input Code
Telugu	2005
Thai	2008
Tibetan	0215
Tigris	2009
Tonga	2015
Turki	2011
Turkish	2018
Twi	2023
Twonga	2019
Ukrainian	2111
Urdu	2118
Uzbek	2126
Vietnamese	2209
Volapuk	2215
Welsh	0325
Worf	2315
Xhosa	2408
Yiddish	1009
Yoruba	2515
Zulu	2621

Symbols

 (Display Mode) Button	70
 (Hang-Up/Back) Button	5, 22
 (Talk) Button.....	5, 22

Numerics

3D Angle Adjustment	73
---------------------------	----

A

Address

Editing Address Book	39
Editing Avoid Area	56
Setting Destination.....	86

Address Book

Editing Address Book	37
Setting Destination.....	92

Address Book PIN.....

Aha™ Radio.....

ATM/Bank (Place Category).....

Audio

Remote Control	142
Settings	143
Touchscreen	6
Voice Commands List.....	312

Audio Menu

<i>Bluetooth</i> ® Audio	199
Disc	158
FM/AM Radio.....	147
HDD	165
Internet Radio	189
iPod®	177
USB Flash drive.....	193

XM® Radio	153
-----------------	-----

Audio System

Auxiliary Input Jack	138
Security Code	139
Theft Protection.....	139
USB Port.....	137

Auxiliary Input Jack

Avoid Streets.....

Avoided Area

B

Black Level.....

Bluetooth® Audio

Playing.....	199
Voice Commands List	314

Bluetooth® HandsFreeLink®

Editing User Name/PIN.....	221, 222
Importing Phonebook Data	212
Making a Call	226
Pairing a Phone.....	206
Phone Settings.....	221
Receiving a Call	231
Setting Up Speed Dialing	213

Brightness.....

C

Calendar

Call

Calculate Route Screen	108, 134
------------------------------	----------

Call History.....

Cancel Route.....

Category

Editing Address Book.....	39
---------------------------	----

Place Category List	320
---------------------------	-----

Setting Destination.....	94
--------------------------	----

Category History

Deleting	45
----------------	----

Change State

City

City Vicinity

Setting Destination.....	95
--------------------------	----

Clock Adjustment

Community (Place Category)

Continue Trip.....

Contrast

Coordinate.....

Correct Vehicle Position.....

Current Location

Current Position

Editing Address Book	39
Setting Destination.....	105

D

Day Mode

Day	69
Night.....	69
Switching Display Mode	70

Delete Tracking

Destination List

Adding Waypoint.....	124
Editing	128

Detour

Dial.....

Directions.....

Disc

Playing	158
Voice Commands List	313

Display Tracking79
 Driving 113
 Setting79
 Download POI
 Editing Category47
 Importing Category46
 Setting Destination102

E

Edit Go Home42
 Edit Home Entry108
 Edit POI Search Radius Along Route54
 Edit/Delete Entry108
 Emergency (Place Category)94
 ENTER Button7
 Error Messages284
 Aha™ Radio289
 CD Player285
 Hard Disc Drive (HDD) Audio286
 iPod®/USB Flash Drive287
 Navigation System284
 Pandora®288
 Estimated Time64
 Exit Info119

F

FM/AM Radio
 Playing147
 Voice Commands List312
 Folder List
 Disc162
 USB Flash Drive198
 Fuel/Auto (Place Category)94

G

Go Home 11
 Go Home PIN43
 Gracenet Info. Update175
 Guidance (Navi Settings)57
 Guidance Mode58
 Guidance Point63

H

HDD
 Playing165
 Voice Commands List312
 Home Address11, 42
 Honda Automobile Customer Service ... 296
 House Number91

I

Import Phonebook Data212
 Interface Dial7
 Intersection104
 iPod®
 Connecting, Disconnecting177, 193
 Playing177
 Voice Commands List313

L

Language Settings33
 Lodging (Place Category)94

M

Map (Navi Settings) 65
 Map Data Update
 Checking Version272
 Obtaining Update Data297
 Map Input
 Editing Avoid Area56
 Setting Destination105
 Map Legend9, 75
 Map Menu116
 Map Screen110
 Changing View72
 Icon9, 77
 Scale76
 Map/Guidance117
 MENU Button
 Changing Route122
 Entering a Destination84
 Multi-View Rear Camera274
 Music Search
 HDD153
 iPod®183
 Phonetic Modification186
 Song By Voice185

N

NAV Button10, 58
 Navigation Menu (Destination)84
 Navigation Menu (Route Option)122
 Next Maneuver Pop up62
 Night Mode
 Switching Display Mode70
 Non-map screens61

- P**
- Pandora® 190
 - Personal Info 36
 - Phone Setup 221
 - Phonebook
 - Importing..... 212
 - Making a Call 227
 - PIN Numbers..... 43
 - Place Category
 - Editing Address Book 39
 - Place Category List..... 320
 - Setting Destination..... 94
 - Place Name
 - Editing Address Book 39
 - Setting Destination..... 96
 - Place Phone Number
 - Editing Address Book 39
 - Setting Destination..... 99
 - Previous Destinations
 - Deleting..... 44
 - Editing Address Book 39
 - Setting Destination..... 93
- R**
- Radio
 - FM/AM 147
 - XM® 153
 - Random
 - Disc 160, 161
 - HDD 168, 169
 - USB Flash Drive 196, 197
 - Rear Entertainment System..... 246
 - Auxiliary Console Panel 246
 - Front Control Panel..... 261
 - HDMI Input Jack 247
 - Rear Control Panel..... 250
 - Wireless Headphones..... 265
 - Rearview Camera..... 274
 - Recreation (Place Category)..... 94
 - Repeat
 - Disc 160, 161
 - HDD 168, 169
 - iPod®..... 181, 182
 - USB Flash Drive..... 196, 197
 - Restaurant (Place Category)..... 94
 - Route Option 122
 - Route Preference..... 50
 - Routing..... 49
- S**
- Scan
 - Disc 160, 161
 - FM/AM Radio 149, 151
 - HDD 168, 169
 - USB Flash Drive..... 196, 197
 - Scenic Road Information 272
 - Scenic Route..... 103
 - Schedule
 - Calendar..... 271
 - Search Along..... 125
 - Search Around 125
 - Search by Name 95
 - Search Nearby 131
 - Security PIN Code..... 292
 - SETTINGS Button..... 4
 - Shopping (Place Category)..... 94
 - Show Icon on Map..... 67
 - Song By Voice™
 - Searching Music 185
 - Setting 184
 - Voice Commands List 312
 - Sort by Distance to Travel..... 95
 - Sound Setup 145, 146
 - Speed Dial
 - Making a Call..... 230
 - Registering 214
 - Straight Line Guide 73
 - Street..... 89
 - Street Name Guidance..... 60
 - System/Device Information 272
- T**
- Touchscreen
 - Basic Operation 6
 - Screen Settings..... 82
 - Shortcuts..... 140
 - Sound Settings 145
 - Traffic Incidents..... 120
 - Traffic List 120
 - Traffic Rerouting 120
 - Auto Reroute 120
 - Navi Settings 53
 - Travel (Place Category) 94
 - Trip Computer 270
- U**
- Unit Settings 32
 - Unverified Routing..... 51
 - Update System Software
 - Finding Update Information..... 297

Obtaining Update Data 297

USB Flash Drive

Connecting, Disconnecting..... 177, 193

Playing 193

Voice Commands List 313

USB Port 137

V

Vehicle

Correct Vehicle Position 80

Off-road Tracking 79

View (Navi Settings) 72

View Area Map 55

View Routes 109

Voice

Map Menu 114

Voice Commands

Basic Operation 8

Help 15

Voice Commands List 308

Voice Control System 22

Voice Control Operation

Basic Operation 5

Voice Portal 5

W

Wallpaper

Deleting, Importing, Setting 29

Waypoint

Adding 124

Deleting, Ordering 128

X

XM® Radio

Playing 153

Voice Commands List 312

Z

ZAGAT

Displaying Review 101

Setting Destination 99

Zip Code 87